



Fone / Fax : 32345460
E-mail: vendas@releved.com.br
www.releved.com.br

PEÇAS ESPECIAIS

ÍNDICE

Linha	Descrição	Página
AGO	Conjunto AGO	3
ANG	Anéis Guia de Nylon	5
AQB	Anéis e Arruelas Especiais em Nitrilica	15
ATF	Anéis e Arruelas de PTFE	21
OR2	Anéis Backup	34
BS	Buffer Seals	35
CAP	Capped Seals	36
GXL	Conjunto Chevron	37

* Medidas ou compostos que não constam nesta lista favor, consultar o nosso departamento de vendas.

VEDAÇÃO AGO

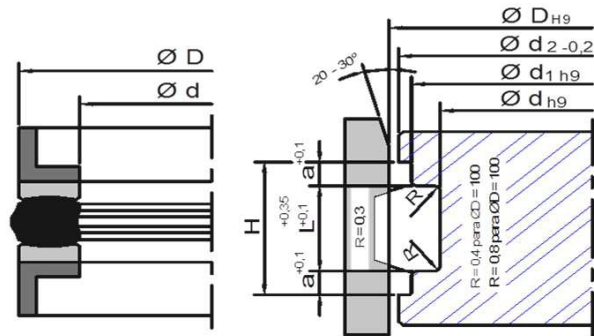

Cilindro

Linha	Código	Ø D	Ø d	h/L	H	d1	d2	a	Obs.
AGO	003200260	32,00	20,00	14,00	20,00	28,00	31,10	3,00	
AGO	003200261	32,00	22,00	15,00	20,00	14,50	31,10	2,50	
AGO	004000260	40,00	24,00	18,40	31,20	35,40	38,70	6,40	
AGO	004000261	40,00	30,00	16,40	30,00	35,00	38,70	6,40	
AGO	004000262	40,85	23,50	20,00	32,00	36,00	39,55	6,40	
AGO	004500261	45,00	32,00	16,00	25,00	39,60	29,70	5,00	
AGO	005000260	50,00	34,00	18,40	31,20	45,40	48,70	6,40	
AGO	005500260	55,00	39,00	18,40	31,20	50,40	53,70	6,40	
AGO	006000260	60,00	44,00	18,40	31,20	55,40	58,70	6,40	
AGO	006000261	60,00	44,00	32,00	44,70	53,80	42,70	6,40	
AGO	006300260	63,00	47,00	19,40	32,20	58,40	61,70	6,40	
AGO	006400260	63,50	47,60	23,80	36,20	58,63	62,20	6,40	
AGO	006500260	65,00	50,00	18,40	31,20	60,40	63,70	6,40	
AGO	007000260	70,00	50,00	22,40	35,20	64,20	68,30	6,40	
AGO	007500260	75,00	55,00	22,40	35,20	69,20	73,30	6,40	
AGO	007600260	76,20	57,15	30,20	42,60	69,55	74,50	6,40	
AGO	008000260	80,00	60,00	22,40	35,20	74,20	78,30	6,40	
AGO	008200260	80,00	66,00	22,50	32,90	74,76	79,40	5,20	
AGO	008500260	85,00	65,00	22,40	35,20	79,20	83,30	6,40	
AGO	008600260	86,00	65,00	22,40	35,20	80,20	84,30	6,40	
AGO	009000260	90,00	70,00	22,40	35,20	84,20	88,30	6,40	
AGO	009200260	92,00	70,00	22,40	35,20	86,00	24,00	6,40	
AGO	009500260	95,00	75,00	22,40	35,20	89,20	93,30	6,40	
AGO	010000260	100,00	75,00	22,40	35,20	93,20	98,00	6,40	
AGO	010500260	105,00	80,00	22,40	35,20	98,20	103,00	6,40	
AGO	010600260	105,80	80,00	22,40	35,20	99,00	103,80	6,40	
AGO	011000260	110,00	85,00	22,40	35,20	103,10	108,00	6,40	
AGO	011000261	110,00	85,00	25,40	35,20	103,10	108,00	5,00	
AGO	011500260	115,00	90,00	22,40	35,20	108,10	113,00	6,40	
AGO	012000260	120,00	95,00	22,40	35,20	113,10	118,00	6,40	
AGO	012200260	122,00	95,00	22,40	35,20	115,10	120,00	6,40	
AGO	012500260	125,00	100,00	25,40	38,20	118,10	123,00	6,40	
AGO	012700260	127,00	102,00	25,40	38,20	120,10	125,00	6,40	
AGO	013000260	130,00	105,00	25,40	38,20	123,10	128,00	6,40	
AGO	013100260	131,90	105,00	25,40	38,20	125,10	130,00	6,40	
AGO	014000260	140,00	115,00	25,40	38,20	133,00	138,00	6,40	
AGO	014000261	140,00	115,00	25,40	45,20	133,00	138,00	10,00	
AGO	014700260	147,00	119,00	25,40	38,20	140,00	145,00	6,40	
AGO	015000260	150,00	125,00	25,40	38,20	143,00	148,00	6,40	
AGO	016000260	160,00	130,00	25,40	38,20	153,00	158,00	6,40	

AGO	016000261	160,00	135,00	25,40	38,20	153,00	158,00	6,40	
AGO	017000260	170,00	140,00	35,40	48,20	163,00	168,00	6,40	
AGO	018000260	180,00	150,00	35,40	48,20	173,00	178,00	6,40	
AGO	018500260	185,70	150,00	25,40	38,20	178,70	183,70	6,40	
AGO	019000260	190,00	165,00	25,40	50,80	181,70	187,00	12,70	
AGO	020000260	200,00	170,00	35,40	48,20	193,00	198,00	6,40	
AGO	022400260	224,75	194,75	25,40	38,20	217,75	223,00	6,40	

ANEIS GUIAS DE NYLON

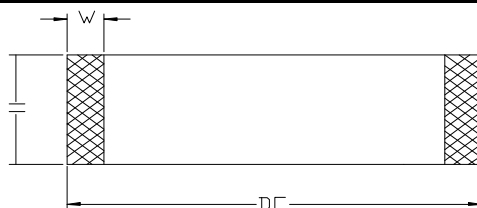

LINHA	CÓDIGO	Ø EXTERNO	W	H	REFERENCIA	Obs.
ANG	9963	14,90	1,00	5,00		
ANG	3781	19,90	1,55	5,00		
ANG	9964	20,90	1,50	5,00		
ANG	AG7061	21,90	3,00	13,00		
ANG	9374	22,00	2,00	9,50	W1-0875-375	
ANG	9595	25,40	2,00	12,70	W1-1000-500	
ANG	5094	27,00	1,50	7,00		
ANG	6687	28,00	2,50	10,00		
ANG	9174	28,60	2,00	13,00		
ANG	5355	29,00	1,80	6,35		
ANG	9191	29,00	2,00	12,20		
ANG	9372	30,00	2,00	7,30		
ANG	5336	30,00	2,00	9,50		
ANG	6740	30,00	2,95	8,00		
ANG	6741	30,00	2,95	13,00		
ANG	6372	31,75	2,00	12,70	W1-1250-500	
ANG	3822	31,75	3,17	12,70	W2-1250-500	
ANG	9373	34,00	2,00	9,50		
ANG	3762	34,80	2,55	10,00		
ANG	AG7476	34,92	3,17	15,88	W2-1375-625	
ANG	AG7570	35,00	1,50	16,00		
ANG	1689	35,00	2,00	9,50	W1-1375-375	
ANG	AG7358	35,56	2,00	12,70	W1-1400-500	
ANG	3650	36,90	2,45	5,40		
ANG	AG7196	38,10	2,00	12,70	W1-1500-500	
ANG	9683	38,10	2,50	4,80		
ANG	5741	38,10	3,17	12,70	W2-1500-500	
ANG	AG7216	39,00	2,00	19,00		
ANG	3763	39,80	2,55	10,00		
ANG	3884	39,80	2,90	10,00		
ANG	9584	40,00	2,50	12,70		
ANG	6908	40,00	3,17	9,50		
ANG	3342	41,00	1,50	21,00		
ANG	3205	41,00	1,50	25,00		
ANG	3343	41,00	1,50	31,30		
ANG	3485	41,00	2,50	5,50		
ANG	6364	41,00	3,00	19,50	6W5-1614-768	
ANG	9112	41,90	2,00	9,50	W1-1650-375	
ANG	1688	41,90	2,00	12,70	W1-1650-500	
ANG	5864	42,00	1,50	4,00		
ANG	AG7001	42,00	2,50	5,60		
ANG	6215	44,00	2,50	9,50		
ANG	5600	44,00	2,70	9,50		
ANG	5862	44,45	3,17	9,50	W2-1750-375	
ANG	5734	44,45	3,17	12,70	W2-1750-500	
ANG	1755	44,45	3,17	15,00		
ANG	5462	45,00	2,00	10,00		

ANEIS GUIAS DE NYLON

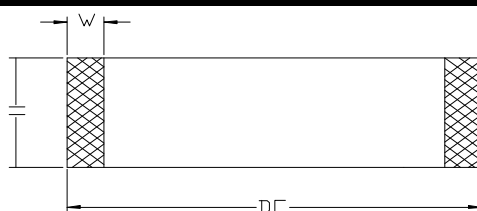

LINHA	CÓDIGO	Ø EXTERNO	W	H	REFERENCIA	Obs.
ANG	3374	45,00	2,50	5,50		
ANG	6352	45,00	2,50	14,00		
ANG	AG7708	45,90	2,95	10,00		
ANG	1224	47,50	1,50	25,40		
ANG	5180	47,50	1,50	25,40		
ANG	6188	47,50	3,17	12,70	W2-1875-500	
ANG	AG7101	47,80	1,90	7,00		
ANG	AG7362	47,90	1,45	22,50		
ANG	6477	48,00	2,00	25,00		
ANG	AG7122	49,00	2,00	8,00		
ANG	5981	49,50	3,17	5,20		
ANG	5957	50,00	3,00	15,00		
ANG	3178	50,00	3,00	23,00		
ANG	AG7352	50,40	3,20	12,70		
ANG	AG7040	50,50	1,50	25,00		
ANG	5059	50,80	2,50	9,50		
ANG	5957	50,80	3,00	15,00		
ANG	5386	50,80	3,17	9,50	W2-2000-375	
ANG	5406	50,80	3,17	10,50		
ANG	1985	50,80	3,17	12,70	W2-2000-500	
ANG	1734	50,80	3,17	19,05	W2-2000-750	
ANG	6115	50,80	4,00	10,00		
ANG	6182	52,00	2,20	6,40		
ANG	AG7423	53,00	1,50	25,00		
ANG	3344	53,50	1,50	20,50		
ANG	AG7179	53,96	1,58	18,50		
ANG	1225	54,00	1,50	25,40		
ANG	5880	54,00	2,50	5,50		
ANG	3094	54,00	3,17	19,05	W2-2125-750	
ANG	1791	55,00	2,50	15,00		
ANG	3121	55,00	3,00	25,00		
ANG	1232	55,00	3,17	9,50		
ANG	6348	56,00	2,50	5,00		
ANG	1790	56,00	2,50	14,00		
ANG	1249	56,00	3,00	28,00		
ANG	3398	56,00	3,17	19,50		
ANG	3345	56,50	1,50	25,40		
ANG	1223	57,10	2,50	15,88		
ANG	AG7097	57,15	3,17	6,35		
ANG	AG7114	57,15	3,17	9,50		
ANG	1445	57,15	3,17	12,70	W2-2250-500	
ANG	3097	57,15	3,17	19,05	W2-2250-750	
ANG	1369	57,15	3,17	22,22	W2-2250-875	
ANG	3765	57,80	2,55	13,00		
ANG	6212	59,00	2,50	5,50		
ANG	3346	59,50	1,50	30,00		
ANG	AG7109	59,80	1,90	7,00		

ANEIS GUIAS DE NYLON

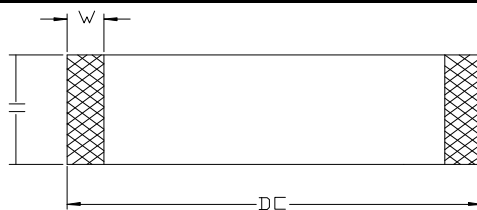

LINHA	CÓDIGO	Ø EXTERNO	W	H	REFERENCIA	Obs.
ANG	3206	60,00	1,50	25,00		
ANG	1273	60,00	1,50	36,70		
ANG	3649	60,00	2,50	5,60		
ANG	AG7446	60,00	2,50	7,00		
ANG	3289	60,00	2,50	15,00		
ANG	AG7099	60,35	1,55	18,40		
ANG	3120	61,00	3,00	25,40		
ANG	3708	61,50	3,17	12,70		
ANG	1116	62,00	3,00	28,00		
ANG	1220	62,00	3,17	9,50	W2-2437-375	
ANG	3399	62,00	3,17	19,05	W2-2437-750	
ANG	3834	62,90	2,95	13,00		
ANG	5907	63,00	2,50	5,50		
ANG	AG7121	63,00	2,90	9,50		
ANG	6867	63,00	3,00	15,00		
ANG	3817	63,00	4,50	12,00		
ANG	3665	63,50	1,50	31,75		
ANG	1687	63,50	2,50	10,00		
ANG	1741	63,50	3,00	15,00		
ANG	1134	63,50	3,17	6,35	W2-2500-250	
ANG	4340	63,50	3,17	9,50	W2-2500-375	
ANG	4111	63,50	3,17	11,00	W2-2500-437	
ANG	1227	63,50	3,17	12,70	W2-2500-500	
ANG	1727	63,50	3,17	15,88	W2-2500-625	
ANG	1229	63,50	3,17	19,05	W2-2500-750	
ANG	1712	63,50	3,17	25,40	W2-2500-1000	
ANG	AG7507	63,90	3,20	39,30		
ANG	6731	64,00	2,40	6,00		
ANG	AG7047	65,00	1,50	15,00		
ANG	5552	65,00	2,50	5,40		
ANG	5084	65,00	2,50	6,00		
ANG	3754	65,00	2,50	18,00		
ANG	6023	65,00	3,00	6,00		
ANG	4580	66,00	1,50	25,00		
ANG	3347	66,50	1,50	25,40		
ANG	3500	66,50	1,50	38,10		
ANG	AG7098	66,68	1,55	18,40		
ANG	AG7477	66,68	1,55	31,75		
ANG	3138	67,00	2,50	40,00		
ANG	AG7125	68,00	2,00	10,00		
ANG	1758	68,00	3,17	12,70		
ANG	AG7382	69,00	3,00	31,50		
ANG	3400	69,00	3,17	19,05		
ANG	6860	69,40	3,80	10,20		
ANG	3196	69,85	3,17	12,70	W2-2750-500	
ANG	3486	70,00	2,50	5,50		
ANG	6232	70,00	2,50	7,00		

ANEIS GUIAS DE NYLON

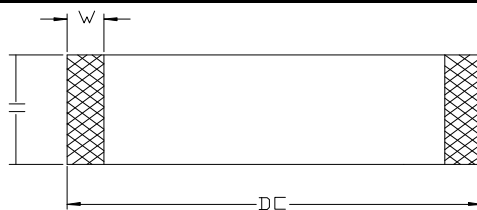

LINHA	CÓDIGO	Ø EXTERNO	W	H	REFERENCIA	Obs.
ANG	5737	70,00	2,50	10,00		
ANG	1793	70,00	2,50	20,00		
ANG	1740	70,00	3,00	15,00		
ANG	AG7100	70,00	3,00	18,00		
ANG	1945	70,00	3,00	28,40		
ANG	1900	70,00	3,17	6,35	W2-2750-250	
ANG	3154	70,00	3,17	9,50	W2-2750-375	
ANG	3349	70,00	3,17	23,50		
ANG	3293	70,00	3,17	44,40	W2-2750-1750	
ANG	3330	70,00	4,00	9,50		
ANG	3348	72,00	1,50	31,00		
ANG	5884	72,00	2,50	5,50		
ANG	3954	73,00	1,50	45,50		
ANG	AG7481	73,00	1,55	25,40		
ANG	6669	73,00	3,00	13,00		
ANG	3940	73,00	3,17	20,00		
ANG	1368	73,02	3,17	22,22	W2-2875-875	
ANG	3764	74,80	2,55	13,00		
ANG	5875	75,00	2,30	9,50		
ANG	5626	75,00	2,50	5,50		
ANG	1390	75,00	2,50	15,00		
ANG	6353	75,00	2,50	18,00		
ANG	AG7469	75,00	3,00	10,00		
ANG	3008	75,00	3,00	13,00		
ANG	3403	75,00	3,00	15,00		
ANG	6924	76,20	2,50	6,35		
ANG	4011	76,20	2,50	9,50		
ANG	1226	76,20	2,50	19,05		
ANG	4013	76,20	3,00	15,00		
ANG	1222	76,20	3,17	9,50	W2-3000-375	
ANG	1771	76,20	3,17	11,00	W2-3000-437	
ANG	1612	76,20	3,17	12,70	W2-3000-500	
ANG	1230	76,20	3,17	15,88	W2-3000-625	
ANG	1147	76,20	3,17	19,05	W2-3000-750	
ANG	1228	76,20	3,17	25,40	W2-3000-1000	
ANG	1362	76,20	3,17	25,40		
ANG	1937	76,20	4,00	13,50		
ANG	1209	76,20	4,70	19,05		
ANG	AG7442	76,34	3,17	39,30		
ANG	AG7108	76,80	2,90	10,00		
ANG	6777	77,00	3,17	8,00		
ANG	3938	77,00	3,50	13,00		
ANG	3969	78,00	4,00	40,00		
ANG	5889	79,00	2,50	5,50		
ANG	1895	79,00	4,70	31,75		
ANG	4241	79,20	1,50	42,00		
ANG	3833	79,90	2,95	13,00		

ANEIS GUIAS DE NYLON

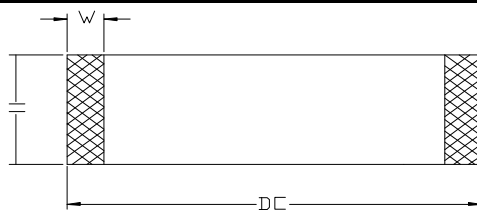

LINHA	CÓDIGO	Ø EXTERNO	W	H	REFERENCIA	Obs.
ANG	1237	80,00	1,50	38,10		
ANG	5847	80,00	2,40	9,50		
ANG	3375	80,00	2,50	5,50		
ANG	5133	80,00	2,50	6,00		
ANG	AG7144	80,00	2,90	10,00		
ANG	1809	80,00	3,00	12,70		
ANG	3179	80,00	3,17	10,00		
ANG	4375	80,00	3,17	12,70		
ANG	AG7709	80,00	4,90	15,00		
ANG	AG7715	80,00	4,90	18,00		
ANG	1159	82,00	3,00	19,00		
ANG	AG7041	82,00	3,20	28,57		
ANG	1409	82,50	3,00	15,00		
ANG	1196	82,50	3,17	9,50	W2-3250-375	
ANG	5721	82,50	3,17	12,70	W2-3250-500	
ANG	3939	82,50	3,17	14,30	W2-3250-562	
ANG	6906	82,50	3,20	15,00		
ANG	4458	82,55	3,17	25,40	w2-3250-1000	
ANG	4459	83,86	3,17	12,70		
ANG	1678	84,00	2,00	15,00		
ANG	3966	84,00	3,00	19,00		
ANG	AG7272	85,00	2,50	15,00		
ANG	1882	85,00	3,00	19,00		
ANG	AG7646	85,50	3,50	19,20		
ANG	4338	85,72	3,17	12,70	W2-3375-500	
ANG	6200	85,73	2,50	9,50		
ANG	1158	86,00	2,50	31,75		
ANG	3085	86,00	3,00	15,00		
ANG	4198	87,50	2,50	50,00		
ANG	4015	88,80	2,50	9,50		
ANG	4014	88,80	3,00	15,00		
ANG	1203	88,80	3,17	9,50	W2-3500-375	
ANG	1852	88,80	3,17	10,00		
ANG	4213	88,80	3,17	11,00	W2-3500-437	
ANG	1446	88,80	3,17	12,70	W2-3500-500	
ANG	3100	88,80	3,17	15,00	---	
ANG	1214	88,80	3,17	15,88	W2-3500-625	
ANG	3093	88,80	3,17	19,05	W2-3500-750	
ANG	1167	88,80	3,17	25,40	W2-3500-1000	
ANG	3350	88,80	3,17	25,40		
ANG	1365	88,80	3,17	38,10	W2-3500-1500	
ANG	1938	88,80	4,00	15,00		
ANG	1329	88,80	4,70	19,05		
ANG	1221	88,90	3,17	28,60	W2-3500-1125	
ANG	1752	90,00	2,00	15,00		
ANG	6226	90,00	2,50	9,50		
ANG	AG7691	90,00	2,50	15,00		

ANEIS GUIAS DE NYLON

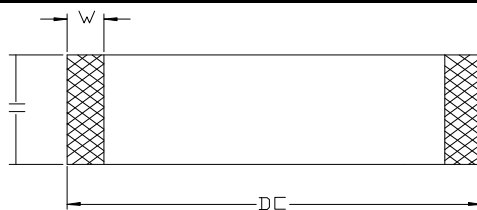

LINHA	CÓDIGO	Ø EXTERNO	W	H	REFERENCIA	Obs.
ANG	AG7691	90,00	2,50	15,00		
ANG	1804	90,00	3,00	9,00		
ANG	1794	90,00	3,00	25,00		
ANG	1190	91,00	3,17	15,88		
ANG	4450	92,07	3,17	12,70	W2-3625-500	
ANG	AG7077	92,50	2,90	10,00		
ANG	3780	93,65	3,17	12,70	W2-3687-500	
ANG	AG7153	95,00	2,50	5,90		
ANG	3407	95,00	2,50	10,00		
ANG	3896	95,00	3,00	29,00		
ANG	3664	95,00	3,17	37,50		
ANG	AG7156	95,00	3,90	6,00		
ANG	4398	95,25	3,17	9,52	W2-3750-375	
ANG	1239	95,25	3,17	12,70	W2-3750-500	
ANG	6765	95,25	3,17	19,05	W2-3750-750	
ANG	AG7357	95,25	3,17	25,40	W2-3750-1000	
ANG	3832	95,80	2,55	13,00		
ANG	3987	96,00	3,00	19,00		
ANG	3720	98,40	3,17	25,40	W2-3875-1000	
ANG	4457	98,70	3,18	12,70		
ANG	AG7111	99,80	2,90	10,00		
ANG	3766	99,80	2,90	13,00		
ANG	4043	100,00	2,00	9,50		
ANG	1743	100,00	2,00	15,00		
ANG	AG7166	100,00	2,50	9,50		
ANG	3406	100,00	2,50	9,70		
ANG	1389	100,00	2,50	15,00		
ANG	1826	100,00	3,00	12,70		
ANG	1962	100,00	3,00	15,00		
ANG	3157	100,00	3,00	25,00		
ANG	4057	100,00	3,00	30,00		
ANG	1504	100,00	3,17	15,00		
ANG	1367	100,00	3,17	15,88		
ANG	1367	100,00	3,17	15,88		
ANG	1711	100,00	4,50	12,00		
ANG	1212	101,40	4,70	20,00		
ANG	4012	101,60	2,50	9,50		
ANG	1197	101,60	3,17	9,50	W2-4000-375	
ANG	1769	101,60	3,17	11,10	W2-4000-437	
ANG	3498	101,60	3,17	12,70	W2-4000-500	
ANG	1215	101,60	3,17	15,88	W2-4000-625	
ANG	1978	101,60	3,17	19,80		
ANG	1363	101,60	3,17	22,20	W2-4000-875	
ANG	3830	101,60	3,17	25,40	W2-4000-1000	
ANG	1370	101,60	3,17	31,75	W2-4000-1250	
ANG	6118	101,60	4,00	10,00		
ANG	3941	104,80	3,17	12,70	W2-4125-500	

ANEIS GUIAS DE NYLON

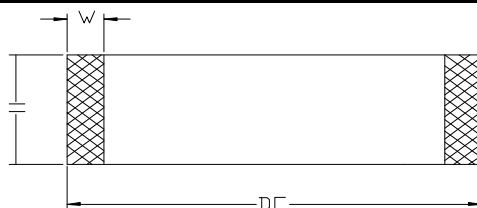

LINHA	CÓDIGO	Ø EXTERNO	W	H	REFERENCIA	Obs.
ANG	AG7164	105,00	2,50	9,50		
ANG	3414	105,00	2,50	15,00		
ANG	6147	105,00	3,00	12,50		
ANG	3844	105,00	3,00	19,00		
ANG	4405	105,00	4,50	10,00		
ANG	4016	107,90	2,50	9,50		
ANG	1231	107,90	3,17	9,50	W2-4250-375	
ANG	1208	107,90	3,17	12,70	W2-4250-500	
ANG	1233	107,90	3,17	15,88	W2-4250-625	
ANG	1301	107,90	3,17	25,40	W2-4250-1000	
ANG	1971	107,90	3,17	38,10	W2-4250-1500	
ANG	4052	110,00	2,50	8,00		
ANG	6272	110,00	2,50	15,00		
ANG	AG7222	110,00	3,00	6,00		
ANG	1810	110,00	3,00	12,00		
ANG	3019	110,00	3,00	13,00		
ANG	1783	110,00	3,00	25,00		
ANG	3663	110,00	3,00	35,00		
ANG	AG7375	110,00	3,15	15,00		
ANG	AG7226	110,00	3,17	7,00		
ANG	1738	110,00	3,30	9,50		
ANG	4053	110,00	4,00	6,10		
ANG	4406	110,00	4,50	10,00		
ANG	3186	110,00	4,50	12,50		
ANG	4100	111,10	3,17	12,70	W2-4375-500	
ANG	3076	112,00	3,00	20,00		
ANG	4082	114,00	3,17	11,10	W2-4500-437	
ANG	3522	114,00	3,17	20,00		
ANG	1972	114,00	4,70	30,00		
ANG	3105	114,20	3,17	15,00		
ANG	1216	114,20	3,17	15,88	W2-4500-625	
ANG	3829	114,20	3,17	25,40	W2-4500-1000	
ANG	1366	114,20	3,17	38,10	W2-4500-1500	
ANG	1282	114,20	4,70	25,40		
ANG	1195	114,20	4,70	38,10		
ANG	3329	114,30	3,17	12,70	W2-4500-500	
ANG	3208	114,30	3,17	19,05	W2-4500-750	
ANG	4382	115,00	2,50	9,50		
ANG	3177	115,00	3,00	10,00		
ANG	4597	115,00	3,00	15,00		
ANG	3986	115,00	3,00	19,00		
ANG	3175	115,00	4,00	10,00		
ANG	AG7246	115,00	4,50	10,00		
ANG	AG7273	115,00	5,00	10,00		
ANG	3634	115,00	5,00	15,00		
ANG	3853	115,40	3,17	6,30		
ANG	AG7319	115,72	3,17	12,70	w2-4556-500	

ANEIS GUIAS DE NYLON

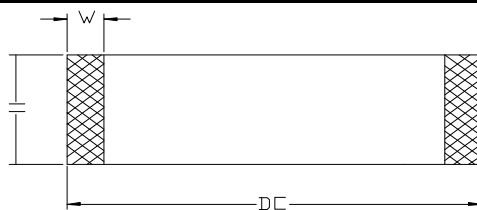

LINHA	CÓDIGO	Ø EXTERNO	W	H	REFERENCIA	Obs.
ANG	4456	116,36	3,17	15,90		
ANG	AG7130	117,00	3,17	12,70		
ANG	3831	117,80	2,55	13,00		
ANG	AG7239	119,00	3,00	5,90		
ANG	3523	120,00	2,50	8,00		
ANG	4384	120,00	2,50	9,50		
ANG	3968	120,00	2,50	15,00		
ANG	4196	120,00	2,80	12,50		
ANG	3488	120,00	3,00	15,00		
ANG	3156	120,00	3,00	30,00		
ANG	3666	120,00	3,00	35,00		
ANG	6721	120,00	3,80	3,20		
ANG	AG7221	120,00	4,00	6,00		
ANG	3524	120,00	4,00	8,00		
ANG	4407	120,00	4,50	10,00		
ANG	3168	120,00	4,50	15,00		
ANG	3674	120,50	3,17	7,00		
ANG	3703	120,50	3,17	25,40	W2-4750-1000	
ANG	1759	120,50	3,40	9,50		
ANG	4221	120,65	3,17	12,70	W2-4750-500	
ANG	4110	120,65	3,17	22,20	W2-4750-875	
ANG	3828	124,90	2,95	13,00		
ANG	3510	125,00	2,50	8,00		
ANG	5850	125,00	2,50	15,00		
ANG	3172	125,00	3,00	10,00		
ANG	1805	125,00	3,00	12,00		
ANG	3020	125,00	3,00	13,00		
ANG	3489	125,00	3,00	15,00		
ANG	1883	125,00	3,00	19,00		
ANG	1407	125,00	3,00	20,00		
ANG	6925	125,00	3,17	12,70		
ANG	1868	125,00	3,17	15,88		
ANG	3511	125,00	4,00	8,00		
ANG	3171	125,00	4,00	10,00		
ANG	AG7710	125,00	5,55	15,00		
ANG	3845	126,00	3,00	19,00		
ANG	1770	127,00	3,17	11,10	W2-5000-437	
ANG	1765	127,00	3,17	12,70	W2-5000-500	
ANG	1217	127,00	3,17	15,88	W2-5000-625	
ANG	3638	127,00	3,17	19,05	W2-5000-750	
ANG	4528	127,00	3,17	25,00	W2-5000-984	
ANG	1294	127,00	3,17	28,40	W2-5000-1125	
ANG	3704	127,00	3,17	44,45	W2-5000-1750	
ANG	1360	127,00	3,20	39,00		
ANG	3332	127,00	3,90	12,70		
ANG	1202	127,00	4,70	20,00		
ANG	1742	127,00	4,70	30,10		

ANEIS GUIAS DE NYLON

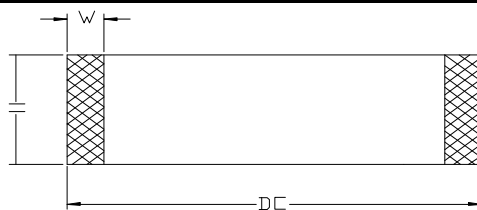

LINHA	CÓDIGO	Ø EXTERNO	W	H	REFERENCIA	Obs.
ANG	1308	127,00	4,70	31,75		
ANG	1201	127,00	4,70	38,10		
ANG	3723	130,00	2,50	8,00		
ANG	AG7356	130,00	2,50	15,00		
ANG	3285	130,00	3,50	15,00		
ANG	3897	130,00	3,50	24,00		
ANG	3635	130,00	3,50	30,00		
ANG	4416	130,20	3,17	9,50	W2-5125-375	
ANG	4688	132,08	2,54	63,50		
ANG	3043	133,30	3,17	15,88	W2-5250-625	
ANG	4379	133,35	3,17	25,90		
ANG	3985	134,00	3,00	19,00		
ANG	4703	134,20	3,05	12,80		
ANG	4381	134,50	3,30	9,50		
ANG	3409	135,00	2,50	8,00		
ANG	3169	135,00	3,50	15,00		
ANG	3490	135,00	3,50	25,00		
ANG	3410	135,00	4,00	8,00		
ANG	3167	135,00	4,00	10,00		
ANG	AG7274	135,00	5,00	10,00		
ANG	3633	135,00	5,00	15,00		
ANG	4330	138,00	3,17	12,70		
ANG	4249	139,50	3,17	12,70	W2-5500-500	
ANG	3709	139,50	3,17	15,88	W2-5500-625	
ANG	1361	139,50	3,17	31,75	W2-5500-1250	
ANG	1287	139,50	3,17	44,40	W2-5500-1750	
ANG	3213	139,70	3,00	12,70		
ANG	4032	140,00	2,50	9,50		
ANG	3074	140,00	3,00	20,00		
ANG	4393	140,00	3,50	20,00		
ANG	3636	140,00	3,50	35,00		
ANG	4033	140,00	4,00	8,00		
ANG	4621	140,00	5,00	15,00		
ANG	4237	141,30	3,17	15,88	W2-5562-625	
ANG	3412	143,00	4,00	8,00		
ANG	6928	143,30	3,17	12,70		
ANG	3411	145,00	2,50	9,70		
ANG	3943	146,00	3,17	12,70	W2-5750-500	
ANG	3586	146,00	3,17	19,05	W2-5750-750	
ANG	3846	147,00	3,00	19,00		
ANG	4380	150,00	3,50	25,00		
ANG	3424	150,00	4,90	15,00		
ANG	3710	152,00	3,00	19,00		
ANG	3705	152,40	3,17	12,70	W2-6000-500	
ANG	1218	152,40	3,17	15,88	W2-6000-625	
ANG	4106	152,40	3,17	25,40	W2-6000-1000	
ANG	1932	152,40	3,17	27,00	W2-6000-1062	

ANEIS GUIAS DE NYLON

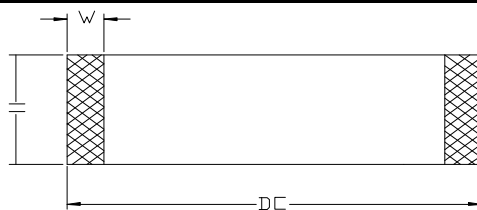

LINHA	CÓDIGO	Ø EXTERNO	W	H	REFERENCIA	Obs.
ANG	1358	152,40	3,17	33,30		
ANG	3668	152,40	3,17	38,10	W2-6000-1500	
ANG	AG7384	152,40	3,17	9,50	W2-6000-375	
ANG	1315	152,40	4,70	31,75		
ANG	1207	152,40	4,70	38,10		
ANG	3984	154,00	3,00	19,00		
ANG	4101	157,00	3,00	20,00		
ANG	3404	157,00	3,17	15,00		
ANG	4323	158,75	3,50	12,70		
ANG	4077	159,60	2,90	13,00		
ANG	3637	160,00	3,50	40,00		
ANG	1830	165,00	3,00	12,70		
ANG	3942	165,00	3,17	12,70	W2-6500-500	
ANG	3711	165,00	3,17	19,05	W2-6500-750	
ANG	1359	165,00	3,17	35,00	W2-6500-1375	
ANG	1343	165,00	3,17	38,10	W2-6500-1500	
ANG	1322	165,00	4,80	31,75		
ANG	1213	165,00	4,80	38,10		
ANG	3847	168,00	3,00	19,00		
ANG	3587	168,20	3,17	19,05	W2-6625-750	
ANG	4251	171,40	3,17	12,70	W2-6750-500	
ANG	4103	171,40	3,17	25,40	W2-6750-1000	
ANG	3983	175,50	3,25	19,00		
ANG	4318	177,80	3,17	9,50	W2-7000-375	
ANG	3582	177,80	3,17	12,70	W2-7000-500	
ANG	3669	177,80	3,17	38,10	W2-7000-1500	
ANG	4199	177,80	3,17	50,80	W2-7000-2000	
ANG	4239	179,80	3,17	15,88	W2-7078-625	
ANG	3670	184,15	3,17	50,80	W2-7250-2000	
ANG	3848	189,00	3,00	19,00		
ANG	3898	190,00	3,50	30,00		
ANG	4319	190,50	3,17	9,52	W2-7500-375	
ANG	4202	190,50	3,17	12,70	W2-7500-500	
ANG	4387	190,50	3,17	19,05	W2-7500-750	
ANG	4172	197,00	3,25	19,00		
ANG	4104	203,20	3,17	12,70	W2-8000-500	
ANG	1836	203,20	6,35	12,70		
ANG	4522	220,00	3,25	19,00		
ANG	4687	234,95	3,17	57,15		

ANÉIS DE PERFIL QUADRADO E ARRUELAS STD. EM NITRILICA

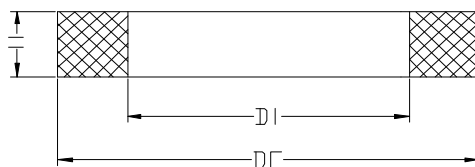

Linha	Codigo	Ø INTERNO	Ø EXTERNO	H	USADO C/ ATF	Obs.
AQB	9496	5,00	12,00	2,00		
AQB	6783	5,80	14,90	2,00		
AQB	9116	6,00	10,00	2,00		
AQB	9706	7,00	20,00	3,00		
AQB	5042	7,50	11,00	1,70		
AQB	6140	8,00	14,00	2,50		
AQB	9294	8,60	12,00	1,50		
AQB	5032	9,00	12,40	1,70		
AQB	5109	9,70	16,00	3,20		
AQB	9556	10,50	23,00	2,30		
AQB	9654	10,70	14,30	2,20		
AQB	5041	11,00	14,50	1,50		
AQB	5033	12,00	15,00	1,50		
AQB	9159	12,40	19,00	3,30		
AQB	5031	14,00	19,40	2,70		
AQB	5393	18,40	21,00	1,50		
AQB	5054	19,00	25,50	3,20		
AQB	5344	20,30	25,70	2,70		
AQB	9151	21,00	24,00	3,00		
AQB	5376	21,00	26,00	2,70		
AQB	9708	21,60	25,20	1,65		
AQB	5174	22,20	28,60	3,20		
AQB	5173	22,80	34,20	3,50	9014	
AQB	9709	23,20	28,30	3,50		
AQB	6007	23,40	27,00	1,80		
AQB	9653	24,20	27,20	2,00		
AQB	5050	25,00	29,00	2,00		
AQB	9213	25,00	29,00	3,00		
AQB	6262	25,00	31,60	3,50		
AQB	5237	25,00	32,00	3,50		
AQB	6888	26,00	35,00	5,00	6715	
AQB	5439	26,70	38,70	3,00		
AQB	9484	28,00	35,00	3,50	6715	
AQB	9840	28,50	35,50	3,60		
AQB	9593	30,30	35,30	2,00		
AQB	5360	30,70	36,10	2,70		
AQB	5182	31,70	37,80	6,50		
AQB	6722	32,00	44,50	2,50		
AQB	5046	32,50	37,50	2,50		
AQB	6863	35,00	45,60	5,00		
AQB	3376	35,80	41,00	5,40		
AQB	5691	36,20	46,00	5,30	5688	
AQB	5400	36,30	46,30	5,00	1107	
AQB	5630	37,40	45,00	1,00		

ANÉIS DE PERFIL QUADRADO E ARRUELAS STD. EM NITRILICA

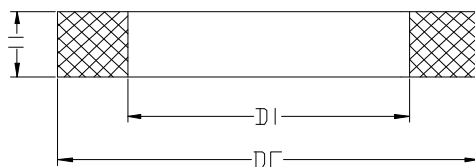

Linha	Codigo	Ø INTERNO	Ø EXTERNO	H	USADO C/ ATF	Obs.
AQB	6826	38,70	45,60	3,60		
AQB	9973	39,00	41,60	1,80		
AQB	5341	39,00	44,00	2,50		
AQB	5546	40,70	47,70	7,00		
AQB	5942	41,30	54,30	2,40		
AQB	4252	42,00	50,00	6,50		
AQB	5631	42,30	53,60	2,80		
AQB	9054	42,80	48,00	2,60	5122	
AQB	9505	43,60	56,60	5,00	9506	
AQB	AG7497	44,00	50,80	2,30		
AQB	6717	44,15	57,35	6,50		
AQB	3378	45,00	50,00	5,00		
AQB	6690	45,10	47,90	1,30		
AQB	9352	45,50	50,50	2,50		
AQB	1274	45,50	55,50	5,00	1110	
AQB	5450	46,10	50,50	1,80		
AQB	AG7628	46,70	58,50	4,50		
AQB	9351	46,80	50,00	1,60		
AQB	9971	47,00	51,60	2,50		
AQB	5628	48,00	63,00	1,50		
AQB	AG7123	49,00	53,80	3,00		
AQB	AG7558	49,00	55,20	15,00		
AQB	1271	49,00	59,00	5,00	1103	
AQB	9972	49,50	52,50	2,00		
AQB	AG7344	50,00	53,00	1,50		
AQB	9254	50,00	56,60	2,35		
AQB	9462	51,40	58,00	3,10	5952	
AQB	9587	51,60	66,00	5,00	3155	
AQB	6001	52,00	57,00	2,50		
AQB	5080	52,80	59,60	3,50	5198	
AQB	5390	53,00	58,00	3,20	5198	
AQB	6231	54,00	66,00	5,30		
AQB	1726	54,40	60,40	2,50	5207	
AQB	6871	54,70	60,70	3,20		
AQB	6135	56,00	62,40	3,25	3106	
AQB	1899	56,00	66,00	5,00	1898/3155/6500	
AQB	6989	56,50	62,10	5,00		
AQB	5034	56,70	61,70	2,50		
AQB	6719	56,85	70,00	6,50	6718	
AQB	5542	57,20	62,20	2,50		
AQB	6479	58,00	74,00	6,30	6478	
AQB	AG7255	58,30	63,50	2,60		
AQB	1267	58,60	68,60	5,00	1109/1682	
AQB	1246	58,70	71,90	5,00	1119	

ANÉIS DE PERFIL QUADRADO E ARRUELAS STD. EM NITRILICA

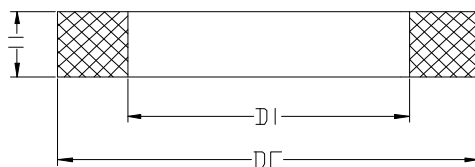

Linha	Codigo	Ø INTERNO	Ø EXTERNO	H	USADO C/ ATF	Obs.
AQB	6400	59,00	65,00	4,00	6399	
AQB	AG7470	59,00	70,50	5,50		
AQB	AG7498	59,80	64,20	3,70		
AQB	6203	59,80	69,80	7,00	5291	
AQB	1349	61,20	66,40	5,40		
AQB	6489	61,40	70,80	5,00	6494	
AQB	1313	62,00	72,00	3,70	1306	
AQB	1278	62,00	72,00	5,00	1100	
AQB	AG7030	62,30	68,70	3,20	3112	
AQB	5350	63,00	69,80	3,40		
AQB	5766	63,10	68,10	2,50		
AQB	6191	63,30	77,90	7,30	6192	
AQB	1378	64,00	70,00	3,00		
AQB	5196	64,30	69,30	2,50		
AQB	1376	64,80	74,40	2,00		
AQB	5235	65,00	70,00	5,40		
AQB	9970	66,00	70,00	3,00		
AQB	6786	66,00	71,00	2,50		
AQB	AG7533	66,00	72,00	3,50		
AQB	1336	66,00	76,00	5,00		
AQB	AG7505	66,00	76,70	3,70		
AQB	6134	66,80	71,20	2,50		
AQB	1277	67,60	78,00	5,20	1095/5415	
AQB	6359	67,70	78,70	3,60		
AQB	6667	68,15	77,15	3,65		
AQB	3471	68,20	75,80	3,70		
AQB	5798	69,00	84,00	7,50	5797	
AQB	5218	69,50	76,50	3,50		
AQB	6653	69,50	82,50	7,50	4145	
AQB	9578	70,30	83,50	5,40	9577	
AQB	1266	71,00	81,00	5,00	1111	
AQB	1392	72,00	82,60	3,00		
AQB	1371	72,00	83,00	2,00		
AQB	5121	72,50	79,30	3,40		
AQB	3532	72,60	82,80	2,50		
AQB	6228	73,40	86,00	5,40		
AQB	1350	73,60	80,00	3,20		
AQB	1312	73,60	83,00	3,60	1305	
AQB	4167	73,95	84,15	6,90		
AQB	1245	74,30	87,70	5,20	1112	
AQB	3570	74,50	85,90	10,00		
AQB	5228	75,20	82,40	3,60		
AQB	1252	75,20	85,40	5,10	1102/3310/5646/6501	
AQB	1352	76,60	82,00	5,40		

ANÉIS DE PERFIL QUADRADO E ARRUELAS STD. EM NITRILICA

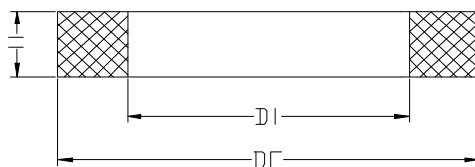

Linha	Codigo	Ø INTERNO	Ø EXTERNO	H	USADO C/ ATF	Obs.
AQB	3312	77,40	87,80	4,00		
AQB	6223	77,80	93,80	7,10		
AQB	5426	78,30	84,90	3,30		
AQB	6280	78,50	83,30	2,40		
AQB	5634	80,00	95,80	6,70	5645	
AQB	3203	81,20	91,40	5,20	3201	
AQB	9100	81,40	84,40	1,50		
AQB	9798	81,50	85,30	2,00		
AQB	9821	82,00	87,00	2,50		
AQB	1279	82,00	96,00	6,50	1096	
AQB	5692	82,30	95,00	6,35	5689	
AQB	1310	82,50	94,50	4,40	1303	
AQB	1690	82,70	96,30	5,00	1303/3287	
AQB	1265	83,60	93,60	5,20	1108/1303	
AQB	1399	84,00	88,00	3,00		
AQB	5331	84,00	91,00	4,60		
AQB	AG7534	84,20	90,20	3,50		
AQB	1200	86,70	96,90	5,10	1092/5179/3689/6503	
AQB	6107	87,50	93,50	6,50	6105	
AQB	1965	87,60	104,00	6,35	1964	
AQB	5592	89,50	94,50	3,30		
AQB	5593	90,00	96,00	3,00		
AQB	5090	90,00	96,80	3,40		
AQB	1283	90,00	103,00	5,10	1098/3311	
AQB	1280	92,70	105,30	6,60	1093	
AQB	3204	94,00	104,00	5,00	3202/6116	
AQB	5693	94,80	107,00	6,10	5690	
AQB	6892	94,95	108,15	6,50	5690	
AQB	3322	95,50	111,60	12,40		
AQB	AG7504	95,90	108,90	5,00		
AQB	9768	96,60	100,60	2,70		
AQB	AG7116	96,70	101,50	3,00		
AQB	1295	97,40	108,80	5,00	1288	
AQB	AG7379	97,50	102,50	3,80		
AQB	1903	97,70	105,70	4,00		
AQB	AG7102	97,80	115,00	6,50		
AQB	AG7131	98,00	111,00	6,50	AG7129	
AQB	6439	98,80	113,80	7,00		
AQB	AG7117	99,00	104,00	2,70		
AQB	5594	100,00	106,40	3,20		
AQB	5429	100,40	107,00	3,50		
AQB	AG7343	100,50	103,80	2,70		
AQB	1286	101,00	111,00	5,00	1104/5647/6504	
AQB	1248	102,50	112,70	3,50		

ANÉIS DE PERFIL QUADRADO E ARRUELAS STD. EM NITRILICA

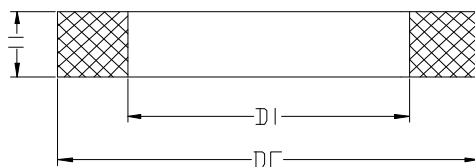

Linha	Codigo	Ø INTERNO	Ø EXTERNO	H	USADO C/ ATF	Obs.
AQB	5607	103,30	117,30	7,00	3512	
AQB	3021	103,40	119,60	6,30	3022	
AQB	1296	104,00	116,00	4,70	1289	
AQB	AG7430	105,00	112,00	3,90		
AQB	6899	105,66	118,85	6,50	3022	
AQB	6304	106,00	123,00	6,00	6306	
AQB	1257	106,60	113,60	3,50		
AQB	AG7205	107,65	120,65	6,50	5680	
AQB	6847	107,70	114,60	3,45		
AQB	1907	107,80	121,00	5,00		
AQB	1309	108,00	123,00	7,70	1101	
AQB	1281	108,20	122,00	6,50	1101	
AQB	5681	108,50	120,70	6,10	5680	
AQB	1272	109,00	119,40	5,00	1268/1870	
AQB	6160	110,00	115,00	1,80		
AQB	3233	110,00	118,00	5,00		
AQB	6143	112,00	125,00	4,50	6142	
AQB	5714	113,20	119,20	6,30	AG7110	
AQB	1887	113,50	121,50	4,00		
AQB	1285	113,60	123,80	5,00	1099/6502	
AQB	AG7337	113,70	118,70	2,50		
AQB	9822	114,00	120,80	3,40		
AQB	6541	114,00	130,50	6,40	6540	
AQB	5467	116,00	126,20	5,10	1318	
AQB	9192	116,50	130,30	3,00		
AQB	3018	118,50	135,00	6,50	1654	
AQB	1269	120,00	130,20	3,10		
AQB	AG7177	120,00	132,00	2,40		
AQB	6889	120,35	133,55	6,50	1654	
AQB	1297	120,50	136,10	7,60	1290	
AQB	AG7372	121,90	132,30	5,20	AG7371	
AQB	6927	124,30	137,30	6,50		
AQB	AG7054	125,40	133,00	6,50		
AQB	AG7062	126,00	133,00	3,50		
AQB	AG7429	127,20	143,70	6,50		
AQB	AG7644	128,00	138,40	5,20		
AQB	1298	128,80	146,60	7,00	1106	
AQB	3520	130,00	137,20	3,60		
AQB	1284	131,20	145,10	6,40	1106	
AQB	9579	132,40	139,00	3,50		
AQB	3678	132,50	145,50	6,80	1106	
AQB	6898	133,05	146,25	6,50		
AQB	5655	133,20	140,00	3,00		
AQB	1264	133,80	143,80	5,00		

ANÉIS DE PERFIL QUADRADO E ARRUELAS STD. EM NITRILICA

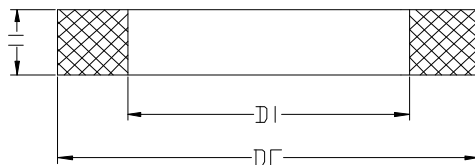

Linha	Codigo	Ø INTERNO	Ø EXTERNO	H	USADO C/ ATF	Obs.
AQB	1036	134,00	144,00	3,00		
AQB	AG7530	135,80	142,00	9,00	AG7528	
AQB	1251	137,80	145,80	2,20		
AQB	5086	138,00	145,00	1,50		
AQB	6896	139,40	152,60	6,50	6895	
AQB	1299	139,80	158,60	7,00	1097	
AQB	1276	141,80	151,80	3,00		
AQB	3234	144,20	150,20	4,00		
AQB	6894	145,75	158,95	6,50	6893	
AQB	1253	146,60	158,60	6,00	1097	
AQB	AG7516	146,70	156,30	5,00		
AQB	5857	148,40	168,40	2,00		
AQB	3677	157,80	171,80	7,00	3676	
AQB	1300	159,10	177,30	7,70	1293	
AQB	6305	165,00	182,00	6,00	6307	
AQB	1311	183,00	204,00	7,70	1304	
AQB	1250	183,30	189,00	4,00		
AQB	6938	185,10	194,50	2,70		
AQB	AG7640	189,50	200,00	5,25		
AQB	3519	190,00	197,00	3,50		
AQB	1261	194,00	204,00	3,70		
AQB	6939	219,30	228,70	2,70		
AQB	6398	278,50	285,10	3,50		
AQB	6396	293,20	300,20	3,50		
AQB	5338	323,50	333,50	4,80		

ANÉIS DE PTFE (E ARRUELAS)

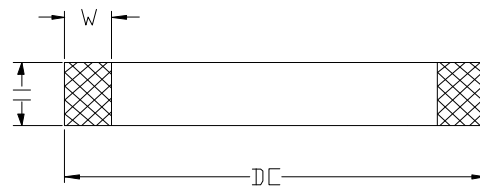

LINHA	CODIGO	Ø EXTERNO	Ø INTERNO	H	W	COR	USADO C/ AQB	Obs.
ATF	9721	6,20	3,10	2,20	1,55	BRANCO		
ATF	9021	7,00	4,20	1,30	1,40	BRANCO		
ATF	9023	8,00	5,80	1,20	1,10	BRANCO		
ATF	9355	9,80	6,80	1,80	1,50	BRANCO		
ATF	9485	10,00	8,00	1,90	1,00	MARROM		
ATF	9262	10,40	6,90	1,70	1,75	BRANCO		
ATF	5243	11,30	9,70	1,90	0,80	BRANCO		
ATF	9261	11,40	8,40	2,20	1,50	BRANCO		
ATF	9740	12,00	8,00	3,50	2,00	BRANCO		
ATF	8109	12,20	7,80	1,20	2,20	BRANCO		
ATF	9095	12,50	8,50	3,40	2,00	BRANCO		
ATF	9757	12,70	7,70	3,50	2,50	CINZA		
ATF	9962	12,70	11,10	1,80	0,80	BRANCO		
ATF	9432	13,00	10,00	1,50	1,50	BRANCO		
ATF	9872	13,00	11,00	0,60	1,00	BRANCO		
ATF	9492	13,70	8,80	2,10	2,45	AZUL		
ATF	9457	13,70	11,50	1,60	1,10	BRANCO		
ATF	9296	14,00	11,00	1,30	1,50	BRANCO		
ATF	9864	14,50	10,50	1,15	2,00	BRANCO		
ATF	9298	14,50	11,50	1,30	1,50	VERMELHO		
ATF	9328	15,20	11,20	1,30	2,00	BRANCO		
ATF	9301	15,20	12,00	1,00	1,60	BRANCO		
ATF	9777	15,50	12,70	1,30	1,40	BRANCO		
ATF	5532	15,50	13,10	3,00	1,20	MARROM		
ATF	5403	16,00	11,60	1,20	2,20	BRANCO		
ATF	5427	16,00	11,60	1,30	2,20	BRANCO		
ATF	9966	16,30	13,00	3,00	1,65	MARROM		
ATF	9455	16,60	14,00	1,20	1,30	BRANCO		
ATF	9533	16,70	14,10	1,20	1,30	BRANCO		
ATF	9411	18,50	15,80	0,85	1,35	BRANCO		
ATF	9519	18,50	15,80	1,20	1,35	BRANCO		
ATF	5062	19,00	14,60	1,00	2,20	BRANCO		
ATF	5392	19,00	14,60	1,30	2,20	BRANCO		
ATF	9744	19,60	16,00	3,20	1,80	BRANCO		
ATF	9752	19,85	15,85	1,30	2,00	BRANCO		
ATF	5282	20,00	15,80	0,50	2,10	BRANCO		
ATF	5521	20,00	16,00	1,30	2,00	BRANCO		
ATF	9063	20,00	18,00	2,00	1,00	BRANCO		
ATF	9452	20,00	18,40	2,00	0,80	AZUL		
ATF	9615	20,20	17,60	3,30	1,30	BRANCO		
ATF	9302	21,00	17,80	1,00	1,60	BRANCO		
ATF	9218	22,00	17,40	1,00	2,30	BRANCO		
ATF	5541	22,00	18,00	0,80	2,00	BRANCO		
ATF	9236	22,00	18,00	1,30	2,00	BRANCO		
ATF	5211	22,00	19,00	1,20	1,50	BRANCO		
ATF	5229	22,00	19,00	2,30	1,50	MARROM		
ATF	9881	22,00	19,30	1,20	1,35	BRANCO		

ANÉIS DE PTFE (E ARRUELAS)



LINHA	CODIGO	Ø EXTERNO	Ø INTERNO	H	W	COR	USADO C/ AQB	Obs.
ATF	9456	22,00	20,00	1,80	1,00	BRANCO		
ATF	9532	22,00	20,00	2,20	1,00	BRANCO		
ATF	5902	22,50	17,50	0,70	2,50	BRANCO		
ATF	5285	22,50	18,90	1,80	1,80	BRANCO		
ATF	5986	22,70	19,20	2,20	1,75	BRANCO		
ATF	9987	22,70	20,30	1,80	1,20	BRANCO		
ATF	9020	23,50	20,70	0,80	1,40	BRANCO		
ATF	9022	23,50	20,70	1,20	1,40	BRANCO		
ATF	9756	23,50	20,80	2,30	1,35	BRANCO		
ATF	9883	24,00	15,75	1,50	4,13	MARROM		
ATF	5213	24,00	22,00	2,20	1,00	BRANCO		
ATF	9520	24,30	21,20	1,50	1,55	BRANCO		
ATF	9453	24,70	21,50	1,60	1,60	AZUL		
ATF	9158	24,80	20,80	1,10	2,00	BRANCO		
ATF	9801	24,80	20,80	1,10	2,00	BRANCO		
ATF	9141	25,00	23,00	3,80	1,00	CINZA		
ATF	9138	25,30	22,30	1,70	1,50	BRANCO		
ATF	9947	25,30	22,30	3,00	1,50	BRANCO		
ATF	5265	25,40	18,80	0,80	3,30	BRANCO		
ATF	5547	25,40	20,40	1,20	2,50	BRANCO		
ATF	9596	25,40	21,80	3,20	1,80	BRANCO		
ATF	9749	25,50	22,30	3,00	1,60	MARROM		
ATF	9886	26,00	16,00	2,50	5,00	MARROM		
ATF	9017	26,00	23,00	1,20	1,50	BRANCO		
ATF	9034	26,00	23,40	2,00	1,30	BRANCO		
ATF	9299	26,50	20,50	0,80	3,00	BRANCO		
ATF	5316	26,50	21,30	1,00	2,60	BRANCO		
ATF	5252	26,50	22,50	1,00	2,00	BRANCO		
ATF	9451	26,50	24,90	2,00	0,80	AZUL		
ATF	9319	27,00	22,00	2,00	2,50	BRANCO		
ATF	5081	27,50	23,50	1,50	2,00	BRANCO		
ATF	AG7260	27,50	25,00	2,00	1,25	AZUL		
ATF	9889	27,75	19,75	1,50	4,00	MARROM		
ATF	AG7258	27,90	25,10	3,00	1,40	BRANCO		
ATF	9185	28,00	23,60	1,00	2,20	BRANCO		
ATF	9609	28,00	24,30	3,20	1,85	BRANCO		
ATF	9454	28,50	25,90	2,00	1,30	BRANCO		
ATF	9097	28,50	26,20	1,80	1,15	CINZA		
ATF	9669	28,70	26,00	1,40	1,35	BRANCO		
ATF	9143	29,00	22,80	1,65	3,10	BRANCO		
ATF	9029	29,00	25,20	2,00	1,90	BRANCO		
ATF	9536	29,00	26,00	2,30	1,50	BRANCO		
ATF	AG7259	29,00	26,20	2,00	1,40	CINZA		
ATF	9892	30,00	20,00	1,90	5,00	MARROM		
ATF	9145	30,00	26,10	2,50	1,95	BRANCO		
ATF	9574	30,00	26,40	0,80	1,80	BRANCO		
ATF	5232	30,00	28,00	2,40	1,00	BRANCO		

ANÉIS DE PTFE (E ARRUELAS)



LINHA	CODIGO	Ø EXTERNO	Ø INTERNO	H	W	COR	USADO C/ AQB	Obs.
ATF	9032	30,50	26,90	2,00	1,80	MARROM		
ATF	5244	30,80	26,80	0,80	2,00	BRANCO		
ATF	9233	31,00	25,00	1,30	3,00	BRANCO		
ATF	9295	31,50	29,90	3,00	0,80	BRANCO		
ATF	9809	31,70	27,30	6,70	2,20	BRANCO		
ATF	9809	31,70	27,30	6,70	2,20	BRANCO		
ATF	5486	31,80	25,80	1,30	3,00	BRANCO		
ATF	6246	32,00	26,00	4,00	3,00	MARROM		
ATF	5125	32,00	27,60	4,00	2,20	BRANCO		
ATF	5996	32,00	28,30	2,50	1,85	BRANCO		
ATF	9943	32,00	28,40	3,00	1,70	MARROM		
ATF	5950	32,00	28,40	3,50	1,80	BRANCO		
ATF	9948	32,40	28,40	3,00	2,00	BRANCO		
ATF	9039	32,50	24,10	2,00	4,20	BRANCO		
ATF	9435	32,50	29,40	2,20	1,55	BRANCO		
ATF	9434	32,70	29,00	2,50	1,85	BRANCO		
ATF	9240	33,00	29,00	2,50	2,00	VERDE		
ATF	9048	33,00	31,40	2,20	0,80	BRANCO		
ATF	9300	33,20	29,20	1,20	2,00	BRANCO		
ATF	5223	33,40	16,80	0,50	8,30	BRANCO		
ATF	9866	33,40	30,40	1,80	1,50	CINZA		
ATF	9028	34,00	32,00	3,50	1,00	BRANCO		
ATF	9528	35,00	29,70	2,00	2,65	BRANCO		
ATF	9134	35,00	31,40	2,50	1,80	AZUL		
ATF	9038	35,00	32,20	2,00	1,40	BRANCO		
ATF	6259	35,50	31,50	2,20	2,00	VERMELHO		
ATF	9913	35,50	31,50	2,20	2,00	BRANCO		
ATF	9439	35,50	32,50	1,50	1,50	CINZA		
ATF	9070	35,80	32,00	1,90	1,90	CINZA		
ATF	5751	36,00	22,20	4,10	6,90	BRANCO		
ATF	9436	36,00	33,00	1,90	1,50	AZUL		
ATF	9221	36,20	32,70	2,50	1,75	AZUL		
ATF	9551	36,50	32,10	0,80	2,20	BRANCO		
ATF	AG7089	36,60	33,50	1,90	1,55	CINZA		
ATF	9984	36,70	33,70	2,80	1,50	CINZA		
ATF	9713	37,10	33,10	2,50	2,00	MARROM		
ATF	AG7261	37,20	34,70	2,00	1,25	BRANCO		
ATF	9986	37,30	33,50	2,30	1,90	AMARELO		
ATF	9707	37,30	34,00	1,00	1,65	BRANCO		
ATF	9714	37,30	34,00	2,00	1,65	MARROM		
ATF	9459	37,50	34,90	4,00	1,30	BRANCO		
ATF	9521	38,00	33,00	2,30	2,50	CINZA		
ATF	9009	38,00	33,00	4,00	2,50	BRANCO		
ATF	9838	38,00	33,00	9,50	2,50	MARROM		
ATF	9133	38,00	34,30	1,90	1,85	VERDE		
ATF	9800	38,00	34,30	2,20	1,85	BRANCO		
ATF	9200	38,00	34,50	1,90	1,90	AZUL		

ANÉIS DE PTFE (E ARRUELAS)



LINHA	CODIGO	Ø EXTERNO	Ø INTERNO	H	W	COR	USADO C/ AQB	Obs.
ATF	9379	38,00	35,00	2,20	1,50	BRANCO		
ATF	9008	38,00	35,00	2,50	1,50	BRANCO		
ATF	9036	38,00	35,40	2,00	1,30	BRANCO		
ATF	9117	38,00	35,80	2,00	1,10	VERDE		
ATF	9117	38,00	35,80	2,00	1,10	VERDE		
ATF	5210	38,10	32,10	3,50	3,00	BRANCO		
ATF	9055	38,10	33,10	3,50	2,50	BRANCO		
ATF	5554	38,10	33,70	3,00	2,20	BRANCO		
ATF	9014	38,20	32,20	4,10	3,00	BRANCO	5173	
ATF	5502	38,50	34,50	1,20	2,00	BRANCO		
ATF	9440	38,50	34,70	2,20	1,90	BRANCO		
ATF	9381	38,50	35,50	2,00	1,50	BRANCO		
ATF	9682	38,70	35,70	2,30	1,50	BRANCO		
ATF	5548	39,00	35,00	3,70	2,00	BRANCO		
ATF	9461	39,00	35,40	2,00	1,80	BRANCO		
ATF	9750	39,00	35,40	3,00	1,80	MARROM		
ATF	9823	39,80	35,60	3,00	2,10	AZUL		
ATF	9389	39,90	33,50	4,50	3,20	BRANCO		
ATF	5292	40,00	34,00	1,50	3,00	BRANCO		
ATF	9464	40,00	34,00	4,50	3,00	BRANCO		
ATF	9322	40,00	35,00	1,50	2,50	BRANCO		
ATF	9175	40,00	35,00	2,50	2,50	AZUL		
ATF	9076	40,00	35,00	2,80	2,50	BRANCO		
ATF	9534	40,00	35,20	1,30	2,40	BRANCO		
ATF	6715	40,00	35,20	6,00	2,40	CINZA	9484	
ATF	9322	40,00	35,40	1,50	2,30	BRANCO		
ATF	9852	40,00	35,40	4,00	2,30	BRANCO		
ATF	5503	40,00	36,00	1,40	2,00	BRANCO		
ATF	5503	40,00	36,00	1,40	2,00	BRANCO		
ATF	9010	40,00	36,00	4,70	2,00	BRANCO		
ATF	5520	40,00	36,00	4,80	2,00	BRANCO		
ATF	9142	40,00	36,20	2,00	1,90	VERDE		
ATF	9132	40,00	36,50	2,50	1,75	VERDE		
ATF	5524	40,00	36,60	5,00	1,70	BRANCO		
ATF	9092	40,00	37,00	1,95	1,50	BRANCO		
ATF	9037	40,00	37,40	2,00	1,30	BRANCO		
ATF	9753	40,15	36,75	2,50	1,70	BRANCO		
ATF	6849	40,30	32,70	4,50	3,80	BRANCO		
ATF	9144	40,30	34,10	4,35	3,10	BRANCO		
ATF	9689	40,40	35,20	3,90	2,60	MARROM		
ATF	9049	40,80	37,00	1,90	1,90	CINZA		
ATF	9030	41,00	37,20	2,50	1,90	VERDE		
ATF	6930	41,10	34,90	19,00	3,10	CINZA		
ATF	9441	41,40	36,80	2,30	2,30	AZUL		
ATF	9094	41,40	37,00	2,30	2,20	BRANCO		
ATF	6070	41,50	35,90	2,00	2,80	BRANCO		
ATF	9217	41,50	36,50	4,60	2,50	BRANCO		

ANÉIS DE PTFE (E ARRUELAS)

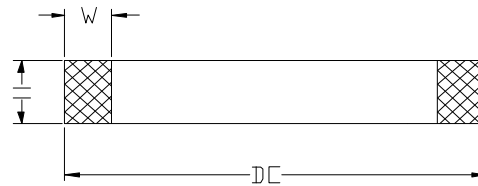

LINHA	CODIGO	Ø EXTERNO	Ø INTERNO	H	W	COR	USADO C/ AQB	Obs.
ATF	9989	41,50	37,50	1,85	2,00	AZUL		
ATF	9522	41,50	37,80	2,00	1,85	MARROM		
ATF	9529	41,50	39,30	2,00	1,10	BRANCO		
ATF	9090	41,70	38,50	2,00	1,60	BRANCO		
ATF	9688	41,80	36,80	5,30	2,50	BRANCO		
ATF	9238	42,00	37,60	3,00	2,20	BRANCO		
ATF	9448	42,00	38,00	2,00	2,00	BRANCO		
ATF	9525	42,00	38,40	3,50	1,80	BRANCO		
ATF	5357	42,60	37,80	2,50	2,40	CINZA		
ATF	AG7235	42,80	39,60	2,15	1,60	BRANCO		
ATF	9693	42,80	39,60	3,00	1,60	VERDE		
ATF	9263	42,90	39,20	2,00	1,85	VERMELHO		
ATF	9988	43,00	39,00	1,50	2,00	BRANCO		
ATF	9259	43,30	40,60	2,00	1,35	BRANCO		
ATF	9524	43,50	41,50	2,00	1,00	BRANCO		
ATF	9513	43,60	40,00	2,50	1,80	AMARELO		
ATF	9477	44,00	40,40	2,50	1,80	BRANCO		
ATF	9035	44,40	31,80	1,60	6,30	BRANCO		
ATF	5455	44,45	38,05	4,50	3,20	BRANCO		
ATF	5097	44,45	39,85	3,80	2,30	BRANCO		
ATF	6248	44,45	41,25	3,20	1,60	BRANCO		
ATF	9119	44,50	39,30	2,00	2,60	BRANCO		
ATF	5340	44,50	39,50	1,20	2,50	BRANCO		
ATF	5861	44,50	41,30	3,00	1,60	BRANCO		
ATF	9985	44,70	41,00	2,00	1,85	CINZA		
ATF	1696	45,00	40,00	2,30	2,50	BRANCO		
ATF	5263	45,00	40,60	4,00	2,20	BRANCO		
ATF	5949	45,00	40,60	4,50	2,20	BRANCO		
ATF	9120	45,00	41,40	3,50	1,80	BRANCO		
ATF	9463	45,00	42,40	2,00	1,30	BRANCO		
ATF	9824	45,30	41,80	2,00	1,75	PRETO		
ATF	9480	45,50	42,30	2,00	1,60	AZUL		
ATF	9699	45,60	36,60	3,70	4,50	MARROM		
ATF	9518	45,70	42,10	1,80	1,80	MARROM		
ATF	5454	46,00	41,20	2,15	2,40	CINZA		
ATF	9553	46,20	42,50	1,90	1,85	MARROM		
ATF	9478	46,40	43,00	1,70	2,10	BRANCO		
ATF	9599	46,50	40,50	1,30	3,00	BRANCO		
ATF	9599	46,50	40,50	1,30	3,00	BRANCO		
ATF	9605	46,50	40,50	2,40	3,00	BRANCO		
ATF	9605	46,50	40,50	2,40	3,00	BRANCO		
ATF	9121	47,00	45,00	2,00	1,00	BRANCO		
ATF	9033	47,60	44,00	2,70	1,80	BRANCO		
ATF	9027	47,70	44,30	2,80	1,70	AZUL		
ATF	5615	48,00	42,60	6,00	2,70	BRANCO		
ATF	9442	48,00	44,20	2,90	1,90	VERDE		
ATF	9140	48,00	44,40	2,90	1,80	AZUL		

ANÉIS DE PTFE (E ARRUELAS)

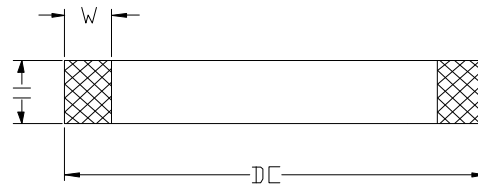

LINHA	CODIGO	Ø EXTERNO	Ø INTERNO	H	W	COR	USADO C/ AQB	Obs.
ATF	9243	48,50	43,50	1,30	2,50	BRANCO		
ATF	9867	48,70	45,70	2,50	1,50	BRANCO		
ATF	9705	48,90	44,30	2,40	2,30	MARROM		
ATF	9466	49,00	44,40	2,00	2,30	BRANCO		
ATF	9438	49,70	46,50	2,40	1,60	AZUL		
ATF	6577	50,00	44,00	6,00	3,00	BRANCO		
ATF	6577	50,00	44,00	6,00	3,00	BRANCO		
ATF	5688	50,00	45,20	6,00	2,40	CINZA	5691	
ATF	3073	50,00	46,00	4,60	2,00	BRANCO		
ATF	5982	50,00	46,00	4,70	2,00	MARROM		
ATF	9007	50,00	47,40	2,00	1,30	BRANCO		
ATF	9842	50,20	45,20	4,10	2,50	CINZA		
ATF	9606	50,50	45,50	6,10	2,50	BRANCO		
ATF	AG7090	50,50	47,30	2,15	1,60	BRANCO		
ATF	6244	50,80	43,20	4,50	3,80	MARROM		
ATF	6578	50,80	44,40	3,50	3,20	MARROM		
ATF	6578	50,80	44,40	4,00	3,20	MARROM		
ATF	5293	50,80	44,80	3,00	3,00	BRANCO		
ATF	9616	50,80	47,00	1,90	1,90	BRANCO		
ATF	5859	50,80	47,60	3,20	1,60	BRANCO		
ATF	5988	51,00	47,00	2,00	2,00	BRANCO		
ATF	9564	51,00	47,00	4,20	2,00	BRANCO		
ATF	9135	51,00	47,80	2,50	1,60	BRANCO		
ATF	6058	51,00	49,00	2,00	1,00	BRANCO		
ATF	9954	51,50	47,10	3,80	2,20	BRANCO		
ATF	9215	51,50	48,50	2,10	1,50	AZUL		
ATF	9467	51,50	48,90	2,20	1,30	BRANCO		
ATF	6681	51,70	45,70	1,20	3,00	BRANCO		
ATF	5372	52,00	42,40	1,50	4,80	BRANCO		
ATF	1107	52,00	46,00	6,30	3,00	BRANCO	5400	
ATF	5122	52,00	48,00	3,20	2,00	MARROM	9054	
ATF	5523	52,00	48,00	3,80	2,00	BRANCO		
ATF	6071	52,00	49,50	2,00	1,25	VERDE		
ATF	9081	53,00	48,60	2,20	2,20	BRANCO		
ATF	9862	53,70	48,70	4,00	2,50	MARROM		
ATF	5296	54,00	47,60	3,50	3,20	BRANCO		
ATF	5995	54,00	50,00	2,00	2,00	BRANCO		
ATF	5413	54,00	50,60	3,00	1,70	BRANCO		
ATF	1125	54,80	50,00	45,00	2,40	BRANCO		
ATF	6034	55,00	51,60	2,00	1,70	BRANCO		
ATF	5879	55,50	50,30	4,00	2,60	BRANCO		
ATF	9289	57,00	42,60	0,90	7,20	BRANCO		
ATF	AG7118	57,15	54,35	3,20	1,40	BRANCO		
ATF	9944	57,30	51,90	2,90	2,70	MARROM		
ATF	9849	57,30	51,90	3,80	2,70	CINZA		
ATF	9733	57,40	51,00	3,00	3,20	BRANCO		
ATF	3004	58,00	54,00	3,80	2,00	MARROM		

ANÉIS DE PTFE (E ARRUELAS)

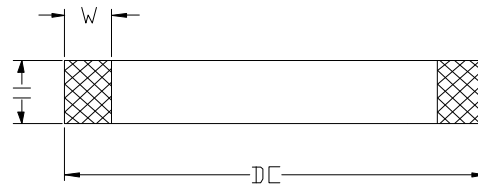

LINHA	CODIGO	Ø EXTERNO	Ø INTERNO	H	W	COR	USADO C/ AQB	Obs.
ATF	6666	58,00	54,00	4,20	2,00	BRANCO		
ATF	6028	58,50	56,50	3,60	1,00	VERMELHO		
ATF	3648	59,00	55,60	2,50	1,70	BRANCO		
ATF	9031	60,00	54,00	1,90	3,00	BRANCO		
ATF	5750	60,10	54,30	1,90	2,90	BRANCO		
ATF	5488	60,30	54,30	3,00	3,00	BRANCO		
ATF	6213	60,40	54,40	4,00	3,00	BRANCO		
ATF	9681	60,80	57,20	2,20	1,80	AZUL		
ATF	6725	60,90	54,90	2,90	3,00	BRANCO		
ATF	5987	61,00	50,60	1,50	5,20	BRANCO		
ATF	5993	61,76	56,06	4,00	2,85	MARROM	2225	
ATF	5257	63,00	50,60	2,10	6,20	BRANCO		
ATF	6245	63,00	55,40	3,60	3,80	BRANCO		
ATF	9378	63,00	55,40	4,50	3,80	MARROM		
ATF	5908	63,00	57,40	3,80	2,80	MARROM		
ATF	9832	63,20	57,20	1,30	3,00	CINZA		
ATF	9506	63,50	57,10	6,00	3,20	BRANCO	9505	
ATF	6716	63,50	57,10	8,00	3,20	CINZA	6717	
ATF	1110	63,50	57,10	10,70	3,20	BRANCO	1274	
ATF	5510	63,50	57,50	3,00	3,00	BRANCO		
ATF	6841	63,50	57,50	3,00	3,00	MARROM		
ATF	5198	63,50	57,50	4,70	3,00	BRANCO	5390/5080	
ATF	5538	63,50	58,30	4,00	2,60	BRANCO		
ATF	1103	63,50	58,70	6,90	2,40	BRANCO	1271	
ATF	1402	63,50	59,50	5,70	2,00	BRANCO		
ATF	5207	63,50	60,50	3,00	1,50	BRANCO	1726	
ATF	9863	64,00	59,00	4,00	2,50	MARROM		
ATF	6247	64,00	59,40	7,00	2,30	MARROM		
ATF	9251	64,80	59,80	1,30	2,50	BRANCO		
ATF	5989	65,00	50,60	1,50	7,20	BRANCO		
ATF	AG7266	65,00	56,00	1,50	4,50	BRANCO		
ATF	AG7000	65,00	56,00	12,00	4,50	MARROM		
ATF	1680	65,00	59,40	6,30	2,80	BRANCO		
ATF	5553	65,00	59,60	4,00	2,70	BRANCO		
ATF	6083	65,00	61,60	2,00	1,70	VERDE		
ATF	6082	65,00	61,80	2,00	1,60	BRANCO		
ATF	5930	67,00	63,40	2,00	1,80	BRANCO		
ATF	AG7159	68,00	63,40	3,00	2,30	BRANCO		
ATF	AG7264	68,00	63,50	3,00	2,25	BRANCO		
ATF	9131	68,00	64,00	2,00	2,00	VERDE		
ATF	6094	69,00	64,40	2,00	2,30	BRANCO		
ATF	9449	69,00	65,60	2,30	1,70	BRANCO		
ATF	9309	69,50	63,50	2,90	3,00	VERMELHO		
ATF	9344	69,50	64,70	1,20	2,40	BRANCO		
ATF	5356	69,85	65,25	4,00	2,30	BRANCO		
ATF	5410	69,85	65,45	3,80	2,20	BRANCO		
ATF	5998	70,00	58,00	1,70	6,00	BRANCO		

ANÉIS DE PTFE (E ARRUELAS)



LINHA	CODIGO	Ø EXTERNO	Ø INTERNO	H	W	COR	USADO C/ AQB	Obs.
ATF	9345	70,00	60,00	2,00	5,00	BRANCO		
ATF	6825	70,00	63,00	5,60	3,50	MARROM		
ATF	9312	70,00	64,40	1,30	2,80	VERMELHO		
ATF	6399	70,00	65,00	4,70	2,50	CINZA	6400	
ATF	3654	70,00	65,00	5,50	2,50	MARROM		
ATF	3155	70,00	65,20	6,90	2,40	BRANCO	1899 / 9587	
ATF	6500	70,00	65,20	6,90	2,40	MARROM	1899	
ATF	9469	70,00	65,80	1,00	2,10	BRANCO		
ATF	9450	70,00	66,40	3,20	1,80	BRANCO		
ATF	9198	70,50	67,10	2,80	1,70	AZUL		
ATF	3503	70,90	65,50	4,00	2,70	MARROM		
ATF	9470	71,00	65,00	1,30	3,00	BRANCO		
ATF	5687	71,00	65,00	6,50	3,00	BRANCO		
ATF	5543	71,00	66,00	1,50	2,50	BRANCO		
ATF	6097	71,00	67,00	1,50	2,00	BRANCO		
ATF	1898	71,00	67,00	5,70	2,00	BRANCO	1899	
ATF	9600	71,50	65,50	1,30	3,00	BRANCO		
ATF	9600	71,50	65,50	1,30	3,00	BRANCO		
ATF	6085	71,50	67,30	1,50	2,10	VERMELHO		
ATF	6046	72,00	66,00	2,00	3,00	BRANCO		
ATF	5883	72,00	66,60	4,00	2,70	MARROM		
ATF	9470	72,30	68,70	2,30	1,80	BRANCO		
ATF	9929	72,60	63,00	2,00	4,80	BRANCO		
ATF	6358	73,50	66,50	6,00	3,50	BRANCO		
ATF	5994	75,00	57,00	1,70	9,00	BRANCO		
ATF	AG7127	75,00	68,80	2,50	3,10	MARROM		
ATF	5625	75,00	69,80	4,00	2,60	CINZA		
ATF	5658	75,00	70,00	1,50	2,50	AZUL		
ATF	6494	75,00	70,00	6,00	2,50	MARROM	6489	
ATF	9471	75,00	72,00	2,20	1,50	BRANCO		
ATF	4112	76,00	70,00	3,90	3,00	MARROM		
ATF	1306	76,00	70,00	4,80	3,00	CINZA	1313	
ATF	AG7238	76,00	70,00	6,30	3,00	BRANCO		
ATF	3072	76,00	71,60	5,80	2,20	BRANCO		
ATF	1119	76,20	69,80	6,35	3,20	BRANCO	1246	
ATF	1109	76,20	69,80	10,70	3,20	BRANCO	1267	
ATF	5291	76,20	69,84	7,94	3,18	CINZA	6203	
ATF	6718	76,20	70,20	8,00	3,00	CINZA	6719	
ATF	6782	76,20	71,40	3,20	2,40	BRANCO		
ATF	5234	76,20	71,40	3,80	2,40	BRANCO		
ATF	AG7280	76,20	71,40	6,90	2,40	AZUL	1278	
ATF	1100	76,20	71,40	6,90	2,40	BRANCO	1278	
ATF	9258	77,00	72,00	1,50	2,50	BRANCO		
ATF	1682	77,78	71,38	11,00	3,20	BRANCO	1267	
ATF	AG7245	78,00	65,40	3,00	6,30	MARROM		
ATF	6579	79,00	73,90	5,50	2,55	BRANCO		
ATF	6579	79,00	73,90	5,50	2,55	BRANCO		

ANÉIS DE PTFE (E ARRUELAS)



LINHA	CODIGO	Ø EXTERNO	Ø INTERNO	H	W	COR	USADO C/ AQB	Obs.
ATF	5485	79,37	72,37	2,00	3,50	BRANCO		
ATF	5945	79,37	74,57	7,50	2,40	MARROM		
ATF	5423	79,40	73,40	1,20	3,00	BRANCO		
ATF	5415	79,40	74,60	6,90	2,40	MARROM	1277	
ATF	9348	80,00	70,00	2,00	5,00	BRANCO		
ATF	5150	80,00	70,80	1,50	4,60	BRANCO		
ATF	4113	80,00	74,00	5,90	3,00	MARROM		
ATF	6478	80,00	74,00	8,00	3,00	MARROM	6479	
ATF	9880	80,00	75,00	1,30	2,40	BRANCO		
ATF	1846	80,00	76,00	4,80	2,00	BRANCO		
ATF	5919	80,00	76,30	2,30	1,85	BRANCO		
ATF	9139	80,00	76,40	2,20	1,80	BRANCO		
ATF	9214	80,00	76,40	2,70	1,80	AZUL		
ATF	5129	80,75	73,75	5,90	3,50	MARROM		
ATF	9286	81,50	74,50	1,50	3,50	BRANCO		
ATF	9601	82,00	74,80	3,60	3,60	AZUL		
ATF	9601	82,00	76,00	3,60	3,00	AZUL		
ATF	3071	82,00	77,00	5,80	2,50	BRANCO		
ATF	6207	82,00	77,40	4,00	2,30	BRANCO		
ATF	4284	82,50	75,60	5,90	3,45	MARROM		
ATF	5722	82,50	76,10	6,00	3,20	BRANCO		
ATF	6192	82,50	76,10	9,30	3,20	BRANCO	6191	
ATF	9575	82,50	76,50	4,65	3,00	BRANCO		
ATF	6240	82,55	76,55	3,00	3,00	BRANCO		
ATF	1095	82,55	77,75	6,90	2,40	BRANCO	1277	
ATF	4325	82,55	77,75	6,90	2,40	MARROM		
ATF	9367	84,00	78,80	1,10	2,60	BRANCO		
ATF	6047	84,50	80,50	1,50	2,00	BRANCO		
ATF	9346	85,00	75,00	2,00	5,00	BRANCO		
ATF	AG7171	85,00	75,00	3,00	5,00	CINZA		
ATF	1487	85,00	78,00	6,00	3,50	CINZA		
ATF	4114	85,00	79,00	5,90	3,00	MARROM		
ATF	5424	85,00	79,20	1,30	2,90	BRANCO		
ATF	6073	85,00	80,00	1,20	2,50	BRANCO		
ATF	6201	85,00	80,00	5,80	2,50	CINZA		
ATF	9275	86,00	76,40	2,20	4,80	BRANCO		
ATF	3101	88,00	83,00	7,50	2,50	MARROM		
ATF	9267	88,50	78,90	1,70	4,80	BRANCO		
ATF	9568	88,60	82,60	1,20	3,00	BRANCO		
ATF	AG7074	88,90	81,90	6,00	3,50	MARROM		
ATF	AG7189	88,90	82,50	8,00	3,20	CINZA		
ATF	4145	88,90	82,50	9,50	3,20	BRANCO	6653	
ATF	1111	88,90	82,50	10,70	3,20	BRANCO	1266	
ATF	1305	88,90	82,90	4,76	3,00	CINZA	1312	
ATF	3310	88,90	83,90	6,90	2,50	MARROM	1252	
ATF	4168	88,90	83,90	8,00	2,50	MARROM		
ATF	5225	88,90	84,10	3,80	2,40	CINZA		

ANÉIS DE PTFE (E ARRUELAS)

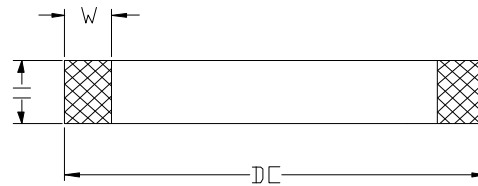

LINHA	CODIGO	Ø EXTERNO	Ø INTERNO	H	W	COR	USADO C/ AQB	Obs.
ATF	5646	88,90	84,10	5,90	2,40	BRANCO	1252	
ATF	1102	88,90	84,30	6,90	2,30	BRANCO	1252	
ATF	6501	88,90	84,30	6,90	2,30	MARROM	1252	
ATF	9845	89,00	83,00	3,10	3,00	BRANCO		
ATF	9577	89,00	83,00	7,40	3,00	BRANCO	9578	
ATF	5797	89,00	83,00	9,40	3,00	BRANCO	5798	
ATF	6178	89,00	84,60	3,80	2,20	CINZA		
ATF	4115	90,00	83,00	5,90	3,50	MARROM		
ATF	5545	90,00	85,20	1,30	2,40	BRANCO		
ATF	6095	90,00	86,00	1,50	2,00	BRANCO		
ATF	AG7251	90,20	84,20	5,90	3,00	MARROM		
ATF	1112	91,00	84,60	6,20	3,20	BRANCO	1245	
ATF	1415	93,00	86,00	6,00	3,50	CINZA		
ATF	6253	94,00	89,00	5,80	2,50	CINZA		
ATF	6648	95,00	80,00	3,00	7,50	CINZA		
ATF	9349	95,00	85,00	2,00	5,00	BRANCO		
ATF	AG7262	95,00	85,00	2,50	5,00	BRANCO		
ATF	4116	95,00	88,00	5,90	3,50	MARROM		
ATF	5482	95,25	90,45	3,80	2,40	BRANCO		
ATF	3201	95,25	90,45	6,90	2,40	MARROM	3203	
ATF	6682	96,70	90,70	3,60	3,00	AZUL		
ATF	9305	98,00	92,40	1,30	2,80	VERMELHO		
ATF	1778	99,00	93,80	6,00	2,60	MARROM		
ATF	9327	99,50	94,50	1,50	2,50	BRANCO		
ATF	9327	99,50	94,50	1,50	2,50	BRANCO		
ATF	AG7168	100,00	90,40	2,00	4,80	BRANCO		
ATF	4117	100,00	93,00	5,90	3,50	MARROM		
ATF	1303	100,00	93,60	6,20	3,20	BRANCO	1310/1690/1265	
ATF	5483	100,00	94,00	1,30	3,00	BRANCO		
ATF	6122	100,00	95,20	1,30	2,40	BRANCO		
ATF	6912	100,20	96,40	7,80	1,90	MARROM		
ATF	3069	101,60	94,40	6,00	3,60	BRANCO		
ATF	9588	101,60	95,00	1,30	3,30	BRANCO		
ATF	5645	101,60	95,20	6,70	3,20	BRANCO	5634	
ATF	1096	101,60	95,20	9,30	3,20	BRANCO	1279	
ATF	1108	101,60	95,20	10,70	3,20	BRANCO	1265	
ATF	5689	101,60	95,24	7,95	3,18	CINZA	5692	
ATF	3287	101,60	95,60	6,20	3,00	CINZA	1690	
ATF	3689	101,60	95,60	7,00	3,00	CINZA	1200	
ATF	5277	101,60	96,80	3,80	2,40	BRANCO		
ATF	5179	101,60	96,80	5,80	2,40	BRANCO	1200	
ATF	1092	101,60	96,80	6,90	2,40	BRANCO	1200	
ATF	6503	101,60	96,80	6,90	2,40	MARROM	1200	
ATF	5991	101,60	98,00	2,30	1,80	BRANCO		
ATF	1698	105,00	95,00	2,50	5,00	BRANCO		
ATF	6148	105,00	100,00	6,00	2,50	MARROM		
ATF	6153	105,00	100,40	1,20	2,30	BRANCO		

ANÉIS DE PTFE (E ARRUELAS)



LINHA	CODIGO	Ø EXTERNO	Ø INTERNO	H	W	COR	USADO C/ AQB	Obs.
ATF	6087	105,00	100,40	7,00	2,30	MARROM		
ATF	3311	107,95	101,95	6,00	3,00	MARROM	1283	
ATF	1098	107,95	101,95	6,20	3,00	CINZA	1283	
ATF	5216	107,95	103,55	3,80	2,20	BRANCO		
ATF	5333	108,00	101,60	1,20	3,20	BRANCO		
ATF	3564	108,00	103,00	15,00	2,50	MARROM		
ATF	3202	108,00	103,20	6,90	2,40	BRANCO	3204	
ATF	6116	109,00	103,80	7,00	2,60	MARROM	3204	
ATF	1779	109,00	104,00	6,00	2,50	MARROM		
ATF	5484	109,50	103,50	1,20	3,00	BRANCO		
ATF	9347	110,00	100,00	2,00	5,00	BRANCO		
ATF	4054	110,00	100,00	8,00	5,00	CINZA		
ATF	1964	110,00	104,00	8,00	3,00	BRANCO	1965	
ATF	5258	111,00	103,20	3,70	3,90	BRANCO		
ATF	3070	111,00	103,80	6,00	3,60	BRANCO		
ATF	5544	111,00	106,00	1,20	2,50	BRANCO		
ATF	9443	111,00	107,20	2,30	1,90	BRANCO		
ATF	5997	111,00	107,20	2,40	1,90	BRANCO		
ATF	9244	111,50	101,50	2,00	5,00	BRANCO		
ATF	6907	111,50	107,50	6,50	2,00	BRANCO		
ATF	5308	114,00	104,00	2,50	5,00	BRANCO		
ATF	9602	114,00	108,00	3,50	3,00	AZUL		
ATF	9602	114,00	108,00	3,60	3,00	AZUL		
ATF	9307	114,00	108,60	1,30	2,70	VERMELHO		
ATF	3103	114,00	109,00	7,50	2,50	MARROM		
ATF	1288	114,30	106,70	6,20	3,80	CINZA	1295	
ATF	1093	114,30	106,70	9,30	3,80	BRANCO	1280	
ATF	1685	114,30	107,90	10,70	3,20	BRANCO		
ATF	5690	114,30	107,94	7,95	3,18	CINZA	5693	
ATF	5647	114,30	109,50	5,90	2,40	BRANCO	1286	
ATF	1104	114,30	109,50	6,90	2,40	BRANCO	1286	
ATF	6504	114,30	109,50	6,90	2,40	MARROM	1286	
ATF	AG7129	117,00	110,65	12,70	3,17	CINZA	AG7131	
ATF	5558	119,00	113,60	6,30	2,70	MARROM		
ATF	9350	120,00	110,00	2,00	5,00	BRANCO		
ATF	3525	120,00	110,00	7,80	5,00	CINZA		
ATF	4118	120,00	113,00	5,90	3,50	MARROM		
ATF	5557	120,00	115,00	1,50	2,50	BRANCO		
ATF	1289	120,65	114,05	6,20	3,30	CINZA	1296	
ATF	5654	124,61	119,37	1,70	2,62	BRANCO		
ATF	5947	125,00	115,00	2,00	5,00	BRANCO		
ATF	3512	125,00	115,00	7,90	5,00	CINZA	5607	
ATF	5682	125,00	118,00	6,00	3,50	BRANCO		
ATF	3173	125,00	118,00	9,50	3,50	MARROM		
ATF	4373	125,00	118,60	6,00	3,50	MARROM		
ATF	1870	125,00	118,60	6,30	3,20	BRANCO	1272	
ATF	3022	125,00	118,60	8,00	3,20	MARROM	3021	

ANÉIS DE PTFE (E ARRUELAS)

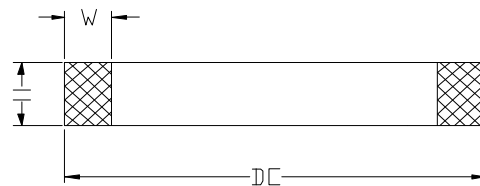

LINHA	CODIGO	Ø EXTERNO	Ø INTERNO	H	W	COR	USADO C/ AQB	Obs.
ATF	6905	125,00	120,00	5,80	2,50	BRANCO		
ATF	1268	125,00	120,00	7,00	2,50	MARROM	1272	
ATF	AG7110	127,00	118,60	7,00	4,20	BRANCO	5714	
ATF	AG7219	127,00	120,60	6,10	3,20	MARROM		
ATF	5736	127,00	120,60	7,00	3,20	CINZA		
ATF	5680	127,00	120,60	8,00	3,20	CINZA	5681	
ATF	1101	127,00	120,60	9,30	3,20	CINZA	1309/1281	
ATF	1684	127,00	120,60	10,70	3,20	BRANCO		
ATF	1099	127,00	122,40	6,90	2,30	BRANCO	1285	
ATF	6502	127,00	122,40	6,90	2,30	MARROM	1285	
ATF	9306	127,80	122,30	1,30	2,75	VERMELHO		
ATF	6142	129,00	122,00	6,00	3,50	MARROM	6143	
ATF	3726	129,50	119,50	8,00	5,00	CINZA		
ATF	9357	129,50	124,50	1,20	2,50			
ATF	3651	130,00	122,90	9,50	3,55	MARROM		
ATF	3550	130,00	124,20	6,30	2,90	MARROM		
ATF	6306	130,00	124,20	7,90	2,90	MARROM	6304	
ATF	1318	130,00	125,20	7,00	2,40	MARROM	5467	
ATF	6848	132,00	123,00	2,60	4,50	BRANCO		
ATF	9696	133,60	129,00	1,30	2,30	BRANCO		
ATF	3408	134,00	124,00	8,00	5,00	CINZA		
ATF	3497	135,00	125,00	2,00	5,00	BRANCO		
ATF	3166	135,00	128,00	9,50	3,50	MARROM		
ATF	6540	135,00	129,00	8,00	3,00	MARROM	6541	
ATF	9363	138,00	131,00	3,00	3,50	BRANCO		
ATF	1654	139,70	133,30	8,00	3,20	CINZA	3018	
ATF	1290	139,70	133,30	9,30	3,20	CINZA	1297	
ATF	4031	140,00	130,00	8,00	5,00	CINZA		
ATF	AG7071	140,00	131,00	2,00	4,50	BRANCO		
ATF	4119	140,00	133,00	7,90	3,50	MARROM		
ATF	3657	140,00	133,00	9,50	3,50	MARROM		
ATF	5731	140,00	135,00	1,20	2,50	BRANCO		
ATF	5683	143,00	133,40	8,00	4,80	BRANCO		
ATF	6926	143,50	137,15	8,00	3,18	CINZA	6927	
ATF	3413	144,50	134,50	8,00	5,00	CINZA		
ATF	3548	151,00	145,20	8,60	2,90	MARROM		
ATF	1106	152,40	144,40	9,30	4,00	CINZA	1298/1284/3678	
ATF	1683	152,40	146,00	10,70	3,20	BRANCO		
ATF	6897	152,40	146,05	8,00	3,18	CINZA	6898	
ATF	5379	153,60	145,20	8,10	4,20	MARROM		
ATF	3589	158,70	148,70	8,00	5,00	BRANCO		
ATF	6895	158,75	152,40	8,00	3,18	CINZA	6896	
ATF	4378	159,10	147,10	8,10	6,00	BRANCO		
ATF	5732	160,00	150,00	2,00	5,00	BRANCO		
ATF	4105	160,00	152,00	7,90	4,00	BRANCO		
ATF	4273	160,00	153,00	7,90	3,50	MARROM		

ANÉIS DE PTFE (E ARRUELAS)



LINHA	CODIGO	Ø EXTERNO	Ø INTERNO	H	W	COR	USADO C/ AQB	Obs.
ATF	3660	160,00	153,00	9,50	3,50	MARROM		
ATF	3551	160,00	154,40	6,30	2,80	MARROM		
ATF	1097	165,00	157,00	9,30	4,00	CINZA	1299/1253	
ATF	6893	165,10	158,75	8,00	3,18	CINZA	6894	
ATF	1356	170,00	159,00	4,70	5,50	BRANCO		
ATF	3676	178,00	171,00	9,30	3,50	CINZA	3677	
ATF	1293	184,15	176,55	9,30	3,80	CINZA	1300	
ATF	6749	189,00	183,40	4,00	2,80	MARROM		
ATF	3557	190,00	184,40	6,50	2,80	MARROM		
ATF	6307	190,00	184,40	7,90	2,80	MARROM	6305	
ATF	6747	202,00	196,40	4,00	2,80	MARROM		
ATF	1304	211,00	203,40	9,30	3,80	CINZA	1311	
ATF	1355	212,70	199,70	4,80	6,50	BRANCO		
ATF	4356	230,00	223,60	9,00	3,20	MARROM	4357	
ATF	6748	232,00	226,40	4,00	2,80	MARROM		

ANÉIS BACKUP EM NITRILICA



LINHA OR2

CÓDIGO	Obs.	CÓDIGO	Obs.	CÓDIGO	Obs.	CÓDIGO	Obs.
8006		8146		8247		8348	
8007		8147		8248		8349	
8008		8149		8249		8350	
8009		8150		8250		8351	
8010		8151		8251		8352	
8011		8152		8252		8353	
8012		8154		8253		8354	
8013		8155		8254		8356	
8014		8205		8255		8357	
8015		8206		8256		8358	
8016		8207		8257		8359	
8017		8208		8258		8360	
8018		8210		8259		8361	
8019		8211		8260		8362	
8021		8212		8261		8363	
8024		8214		8262		8364	
8110		8215		8263		8365	
8111		8216				8366	
8112		8217		8269		8367	
8113		8218		8312		8368	
8114		8219		8314		8372	
8115		8220		8317		8373	
8116		8221		8318		8425	
8117		8222		8320		8426	
8118		8223		8324		8427	
8119		8224		8325		8428	
8120		8225		8326		8432	
8121		8226		8327		8433	
8122		8227		8328		8437	
8123		8228		8329		8439	
8124		8229		8330		8441	
8125		8230		8331		8444	
8126		8231		8332		8446	
8127		8232		8333		8447	
8128		8233		8334			
8129		8234		8335			
8130		8235		8336			
8132		8236		8337			
8133		8237		8338			
8134		8238		8339			
8135		8239		8340			
8136		8240		8341			
8139		8241		8342			
8140		8242		8343			
8141		8243		8344			
8143		8244		8345			
8144		8245		8346			
8145		8246		8347			

BUFFER SEALS

[AP] ANEL + TEFLON C/ BRONZE

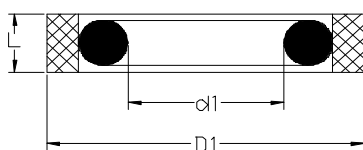

LINHA	CÓDIGO	d1	D1	L	Obs.
BS	AP025	17,50	25,50	2,90	
BS	AP038	30,50	38,00	3,20	
BS	AP076	64,50	76,00	3,90	
BS	AP080	65,00	80,00	5,90	
BS	AP082,5	66,00	82,50	5,90	
BS	AP085	70,00	85,00	5,90	
BS	AP090	75,10	90,00	5,90	
BS	AP095	79,30	95,00	5,90	
BS	AP100	83,50	100,00	5,90	
BS	AP120	104,80	120,00	5,90	
BS	AP127	111,50	127,00	6,30	
BS	AP140	121,80	140,00	7,90	
BS	AP152,4	152,40	131,40	8,10	
BS	AP160	141,20	160,00	7,90	

[AH] ANEL + TEFLON C/ BRONZE

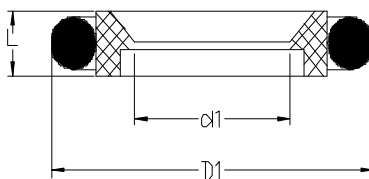

LINHA	CÓDIGO	d1	D1	L	Obs.
BS	AH020	20,00	31,60	3,80	
BS	AH022	22,00	33,60	3,80	
BS	AH025	25,00	36,50	3,80	
BS	AH028	28,00	39,50	3,80	
BS	AH030	30,00	41,40	3,80	
BS	AH032	32,00	43,40	3,80	
BS	AH035	35,00	46,30	3,80	
BS	AH038	38,00	54,50	5,80	
BS	AH040	40,00	56,40	5,80	
BS	AH042	42,00	58,40	5,80	
BS	AH045	45,00	61,30	5,80	
BS	AH050	50,00	66,30	5,80	
BS	AH055	55,00	71,20	5,80	
BS	AH060	60,00	76,00	5,80	
BS	AH063	63,00	79,00	5,80	
BS	AH063,5	63,50	74,20	4,20	
BS	AH065	65,00	81,00	5,80	
BS	AH070	70,00	85,90	5,80	
BS	AH075	75,00	90,80	5,80	
BS	AH080	80,00	95,70	5,80	
BS	AH085	85,00	100,50	5,80	
BS	AH090	90,00	105,50	5,80	
BS	AH095	95,00	110,40	5,80	
BS	AH108	108,00	125,50	5,90	

CAPPED T-SEALS

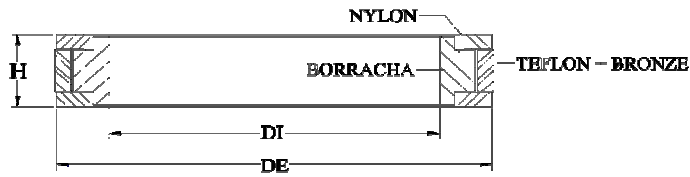

LINHA	Nº AGEL	DI	DE	H	Obs.
CAP	800025	15,00	25,00	8,00	
CAP	800050	38,00	50,00	8,00	
CAP	700057	42,00	57,00	7,00	
CAP	1050070	53,00	70,00	10,50	
CAP	1200080	64,00	80,00	12,00	
CAP	1200090	73,00	90,00	12,00	
CAP	1470889	76,75	88,90	14,70	
CAP	1150095	79,00	95,00	11,50	
CAP	1470095	83,10	95,25	14,70	
CAP	1200100	85,00	100,00	12,00	
CAP	1210100	85,00	100,00	12,00	
CAP	1200105	88,00	105,00	12,00	
CAP	1471016	89,45	101,60	14,70	
CAP	1200110	93,00	110,00	12,00	
CAP	1200115	100,00	115,00	12,00	
CAP	1580125	100,00	125,00	15,80	
CAP	1471143	102,15	114,30	14,70	
CAP	1200120	105,00	120,00	12,00	
CAP	1580130	105,00	130,00	15,80	
CAP	1905127	108,50	127,00	19,05	
CAP	1580135	110,00	135,00	15,80	
CAP	1200130	112,00	130,00	12,00	
CAP	1580140	115,00	140,00	15,80	
CAP	1800150	134,00	150,00	18,00	
CAP	1580160	135,00	160,00	15,80	
CAP	1200160	143,00	160,00	12,00	
CAP	1250190	174,00	190,00	12,50	

CONJUNTO CHEVRON

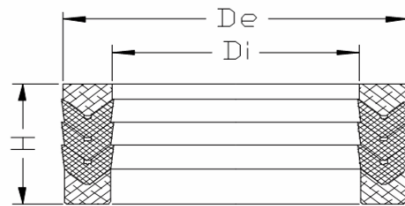

LINHA	Código	Ø INTERNO	Ø EXTERNO	H	Obs.
GXL	001	25,40	44,45	24,00	
GXL	002	28,57	41,27	18,00	
GXL	003	31,75	44,45	22,00	
GXL	005	38,10	50,80	21,00	
GXL	007	41,27	53,97	20,00	
GXL	008	44,45	57,15	19,00	
GXL	009	44,45	63,50	26,00	
GXL	010	48,00	62,00	21,00	
GXL	011	50,80	63,50	20,00	
GXL	012	50,80	66,67	25,00	
GXL	013	50,80	69,85	26,00	
GXL	015	57,15	69,85	20,00	
GXL	016	57,15	73,02	26,00	
GXL	050	57,15	76,20	28,00	
GXL	017	57,15	76,20	38,00	
GXL	018	60,32	76,20	21,00	
GXL	019	63,50	76,20	19,00	
GXL	020	63,50	79,37	28,50	
GXL	021	63,50	82,55	23,80	
GXL	054	65,00	80,00	27,00	
GXL	022	69,85	82,55	24,00	
GXL	023	69,85	88,90	27,00	
GXL	024	70,50	89,30	37,00	
GXL	051	75,00	95,00	30,00	
GXL	025	76,20	101,60	37,00	
GXL	026	82,55	95,25	23,00	
GXL	027	82,55	101,60	28,00	
GXL	028	85,00	104,00	26,00	
GXL	030	88,90	107,95	28,00	
GXL	031	88,90	114,30	34,00	
GXL	052	90,00	110,00	25,00	
GXL	053	93,00	107,00	20,00	
GXL	032	96,00	114,00	26,00	
GXL	033	100,00	125,00	37,00	
GXL	034	103,00	122,00	27,00	
GXL	035	107,95	127,00	25,00	
GXL	036	114,30	139,70	30,00	
GXL	037	120,00	150,00	42,00	